

MINISTRY OF HIGHER EDUCATION
AND SCIENTIFIC RESEARCH
UNIVERSITY OF BASRAH



Iraq, Basrah



(+964) 7802410145



sustainability@uobasrah.edu.iq

UNIVERSITY OF BASRAH
SUSTAINABILITY REPORT 2021



<https://en.sustainability.uobasrah.edu.iq/>



UNIVERSITY OF BASRAH PRESIDENT CHANCELLOR'S SPEECH

Praise be to God, Lord of the Worlds, who bestowed upon us the blessings that made Iraq a country of abundant natural resources and made it a part of this developed world. Since we live in a modern world, it ostensibly may seem civilized, but it daily depletes a lot of natural resources without sufficient awareness of rationalization and maintaining for those resources. In our cities, we point out that the consumption in city centers is much more than what we find in the countryside. For example, the lights in cities remain used even at sunshine; equipment's, electrical appliances, heating and cooling appliances and other equipment that require various kinds of resources are used without considering their use only when needed. This leads to the need of urgent developments of plans and programs to manage the consumption of natural resources, which ensures their preservation and sustainability as much as possible and to find ways and means to get environmentally friendly alternatives that serve same purposes. Therefore, the need for sustainable living be high requirement grade in our responsibility. Certainly, the goal is not to focus just on cities which means sustainable living is a necessity only for cities. Nevertheless, enhancements must be made in ways of living everywhere in the world (unfortunately, it is estimated that we consume about 40% more resources annually than we can bear). This requires changes our behaviors to maintain the sustainability of the natural resources. Therefore, the concept of sustainability is one of the most vital topics that are being discussed at the present time at all levels. Thus, for the university to advance and take its real role in society, one of its most important duties is to increase the awareness of individuals about the effects of our daily practices leave on the environment around us, as well as the depletion of the planet's natural resources unwisely.

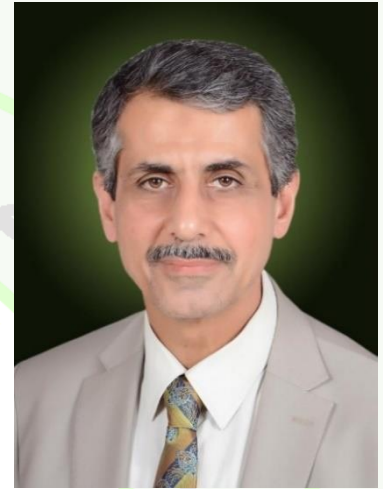

Prof. Dr. Saad Shaheen Hammadi
The Chancellor of the University of Basrah





Contents

UNIVERSITY OF BASRAH PRESIDENT CHANCELLOR'S SPEECH	2
About us	7
Our vision	8
Our Mission	8
Our Goals.....	8
1.1. Geographical location.....	10
1.2. Students and faculty.....	12
1.2.1 The number of students for the academic year 2019/2020.....	12
1.2.2 The number of students for the academic year 2020/2021.....	16
1.2.3 Number of lecturers and administrators.....	19
1.3. Campus Sites	20
1.3.1 Bab Al-Zubair Campus	21
1.3.2 Karmat Ali Campus	22
1.3.3 Al-Bradeya Campus	23
1.3.4 Al-Qurna Campus	24
1.3.5 Dentistry Campus	25
1.4. Green areas.....	26
1.5. Essential Facilities On Campus.....	28
1.5.1 For Disable Special Needs And Or Maternity Care	28
1.5.2 the maternity care.....	31
1.6. Security and safety.....	32

UNIVERSITY OF BASRAH SUSTAINABILITY REPORT



1.7. Health infrastructure.....	40
1.8. Conservation of natural resources.....	46
1.9. Maintenance of university buildings during the pandemic	56
[2] Energy and Climate Change (EC)	60
2.1 Energy Efficient Appliances	60
2.2 Smart Buildings	63
2.3 Renewable Energy Sources in Campus	70
2.4 Green Building	73
2.5 University's Greenhouse Gas Emission Reduction Program	77
2.7. The innovative program(s) during Covid-19 pandemic.....	83
[3] Waste (WS).....	89
3.1 Recycling Program for University Waste.....	89
2.3 Program to Reduce the Use of Paper and Plastic on Campus.....	92
3.3. Organic Waste Treatment	95
3.4 Inorganic Waste Treatment.....	96
3.5 Toxic Waste Treatment	98
3.6 Sewage Disposal.....	99
[4] Water (WR)	101
4.1 Water Conservation Program	101
4.2 Water Recycling Program	104
4.3 Water during Covid-19 pandemic	105
[5] Transportation (TR)	110





5.1. Mass Transport Services.....	110
5.1.1. On-campus transportation service	110
5.1.2. Off-campus transportation service	112
6.1.3. Statistics for the total number of cars (cars and motorcycles) inside the university campus	113
5.2. Zero Emission Vehicles (ZEV) Policy on Campus.....	113
5. 2. 1. Electric Vehicles.....	113
5. 2. 2. Bicycles.....	115
5. 3. The ratio of the parking area to the total area of the campus	116
5. 3. 1. On-campus parking area ratio for Garmat Ali Campus.	117
5. 3. 2. On-campus parking area ratio for Bab Al-Zubair Campus.....	117
5.3.3. On-campus parking area ratio for Al-Baradiyah Campus/ College of Medicine.....	118
5.3.4. On-campus parking area ratio for Al-Baradiyah Campus/ College of Dentistry.....	118
5.3.5. On-campus parking area ratio for Al-Qurna Campus	119
5. 4. University policy to reduce on-campus parking areas.....	119
5.5. Campus Pedestrian Path Policy	121
5. 5. 1. Garmat Ali campus pedestrian path.....	122
5.5.2. Bab Al-Zubair campus pedestrian path	123
5.5.3. College of Medicine campus pedestrian path	125
5.5.4. College of Dentistry campus pedestrian path	126





5.5.5. Al-Qurna campus pedestrian path	127
[6] Education and research (ED)	128
6. 1. Subjects related to sustainability at University of Basrah	128
6. 1. 2. Sustainability research at University of Basrah in 2019 / 2020	179
6. 2. 2. Sustainability patents in 2019/2020	207
6. 3. Some of Sustainability events during 2019 / 2020	208
6. 4. Student organizations on sustainability	225
6. 5. Cultural activities related to sustainability.....	229
6. 6. University programs to deal with the Covid-19 epidemic.....	233
6. 7. Sustainability community services project organized and/or involving students.....	250
6.8. Number of sustainability-related startups:.....	261





About us

In 1964, the University of Basrah was separated from the University of Baghdad, to be the first university in the south of Iraq. It is worth noting that Basrah is the second largest province in Iraq by population. The originality of the University is embodied in its being one of the oldest Iraqi universities, which contributed to the establishment of most universities in the south and middle of Iraq through providing teaching staff, which has undertaken the task of being a role model for management and development.



Precedency of University of Basrah

The University was inaugurated in 1964 with only four faculties: Arts, Science, Engineering, and Law. Right now, it is composed of 21 faculties for undergraduate studies and a faculty of postgraduate studies. These faculties include 67 scientific departments and 41 scientific branches in different disciplines, as well as about 9 research and service centers. The university also provides its services through 11 consulting offices in various scientific specialisms.



Our vision

University of Basrah seeks to be one of the best universities in the Middle East. We hope that this university be recognized internationally for its originality, sobriety and, excellence in the field of universities education, scientific research and, community service in a way that achieves comprehensive and sustainable human development in the Middle East and beyond!

Our Mission

The University of Basrah seeks to:

1. Enable the younger generations to possess knowledge and employ it in the best possible way.
2. Enable researchers to find sustainable solutions to the challenges that facing society.
3. Develop the ability to get solutions for sustainable of production and consumption.
4. Collaborate with various national and international institutions and NGO to exchange knowledge.

Our Goals

University of Basrah sustainability goals are as follows:

Goal 1. "End poverty in all its forms everywhere"

Goal 2. "End hunger, achieve food security, improve nutrition and promote sustainable agriculture"

Goal 3. "Ensure healthy lives and promote well-being for all at all ages"



Goal 4. “ Ensure inclusive and equitable quality education and promote lifelong learning opportunities for all ”

Goal 5. “Achieve gender equality and empower all women and girl”

Goal 6. “ Ensure availability and sustainable management of water and sanitation for all ”

Goal 7. “ Ensure access to affordable, reliable, sustainable and modern energy for all”

Goal 8. “ Promote sustained, inclusive and sustainable economic growth, along with full and productive employment and decent work for all ”

Goal 9. “Build strong infrastructure, promote inclusive and sustainable industrialization and foster innovation”

Goal 10. “ Reduce inequalities within and among countries”

Goal 11. “ Build sustainable cities and communities”

Goal 12. “ Responsible Consumption and production”

Goal 13. “ Take urgent action to combat climate change and its impacts”

Goal 14. “ Conserve and sustain the oceans, sea and marine resources”

Goal 15. “ Conserve and restore terrestrial and freshwater ecosystem”

Goal 16. “Maintain peace and Justice and build strong institutions”

Goal 17. “ Only by working together, can we achieve a sustainable and peaceful world”



[1] Setting and Infrastructure (SI)

1.1. Geographical location

The University of Basrah is located in the Basrah Governorate in southern Iraq, which extends across the Shatt Al-Arab waterway. The governorate is **55 km** (34 miles) away from the Persian Gulf, which represents Iraq's **only sea port** to the sea. This strategic geographical location gave the province an economic weight to be named in April 2019 as **the commercial capital of Iraq** by the Iraqi government and with the approval of the Iraqi parliament.



The geographical location of the University within the province of Basrah gave it an additional role because the province is characterized by:

1. One of the richest Iraqi governorates in natural resources, as it contains the largest oil reservoirs in Iraq.
- 2- It is fertile agriculturally due to the passage of the Shatt al-Arab in its lands.



3- It contains the only external sea port linking Iraq with the rest of the world.

4- The historical and religious dimension of its lands, as it is considered a transit point for migration throughout history.





1.2. Students and faculty

Basrah is considered as one of the largest governorates in Iraq where it has a population of more than 4,700,000 people according to the 2014 census, which represents 13% of the population of Iraq. The province has three public universities: The University of Basrah, Southern technical university, and the University of Basrah for oil and gas. The University of Basra is regarded as the mother university of both other universities due to its antiquity and heritage that made it distinguished by various specializations. The University of Basrah contains 21 colleges for undergraduate studies and a college of graduate.

1.2.1 The number of students for the academic year 2019/2020





The statistic of the morning study students with free government scholarships and the morning privet study students with charge for the academic year 2019 / 2020

Number of Students	Male	Female	Total
Total (2019-2020)	12018	21524	33542
Accepted (2019-2020)	3427	6565	9992
Graduates (2018-2019)	1808	3437	5245

The statistic of the morning study students with free government scholarships and the morning privet study students with charge for the academic year 2019 / 2020

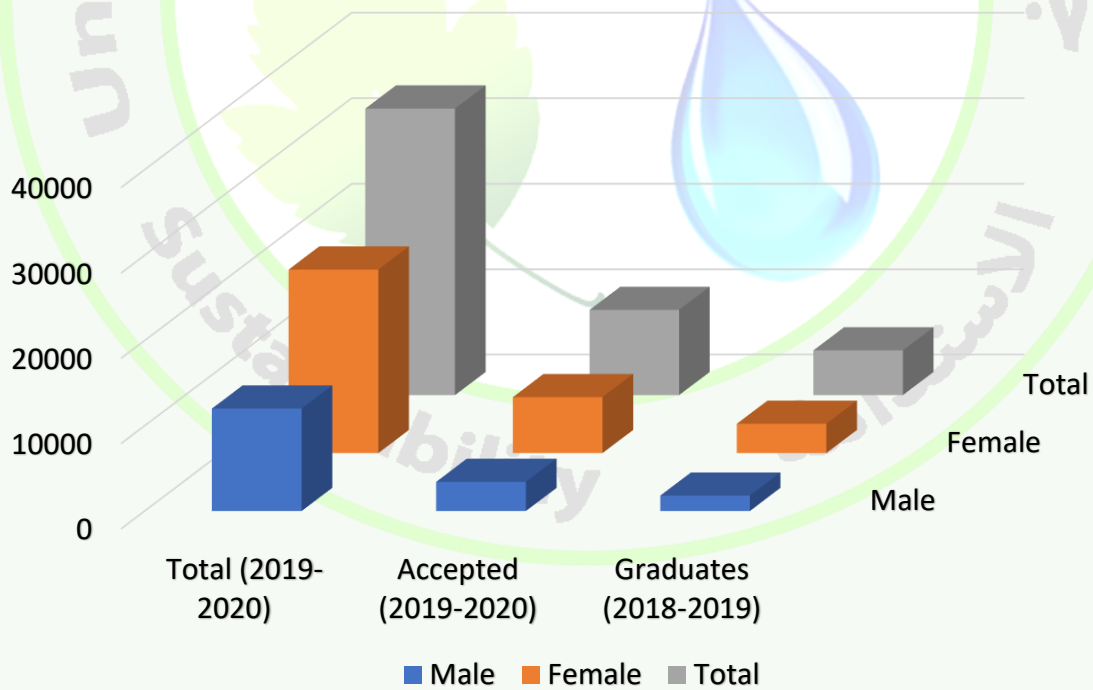



The statistic of the evening study students with charge for the academic year 2019 / 2020

Number of Students	Male	Female	Total
Total (2019-2020)	6227	4762	10989
Accepted (2019-2020)	1835	1314	3149
Graduates (2018-2019)	806	488	1294

Statistics of the evening study students with charge for the academic year 2019 / 2020

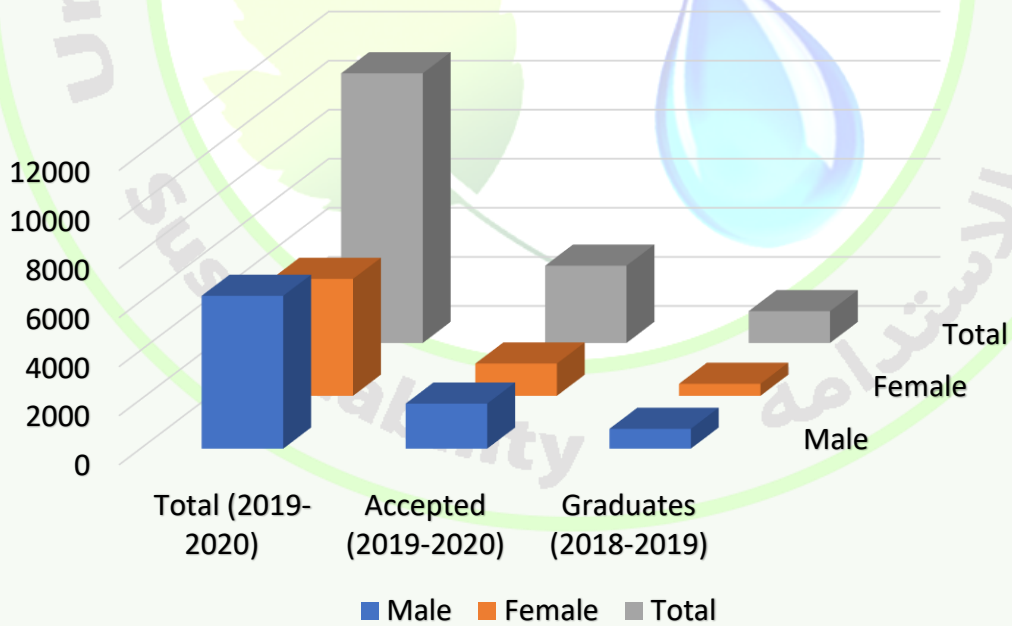



Statistics of total students of the University of Basrah for the academic year 2019 / 2020 for both morning and evening study

Number of Students	Male	Female	Total
Total (2019-2020)	18245	26286	44531
Accepted (2019-2020)	5262	7879	13141
Graduates (2018-2019)	2614	3925	6539

The statistic of Total students of the University of Basrah for the academic year 2019 / 2020

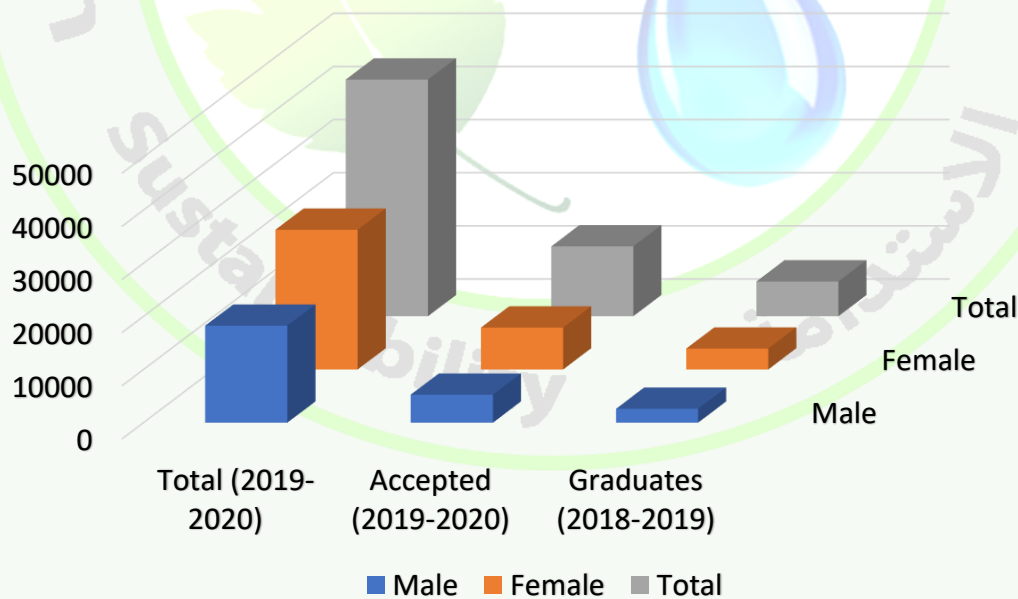



1.2.2 The number of students for the academic year 2020/2021

Statistics of the morning study students with free government scholarships and the morning private study students with charge for the academic year 2020 / 2021

Number of Students	Male	Female	Total
Total (2019-2020)	16314	28217	44531
Accepted (2019-2020)	8026	12677	20703
Graduates (2018-2019)	2244	3888	6132

Statistic of the morning study students with free government scholarships and the morning private study students with charge for the academic year 2020 / 2021

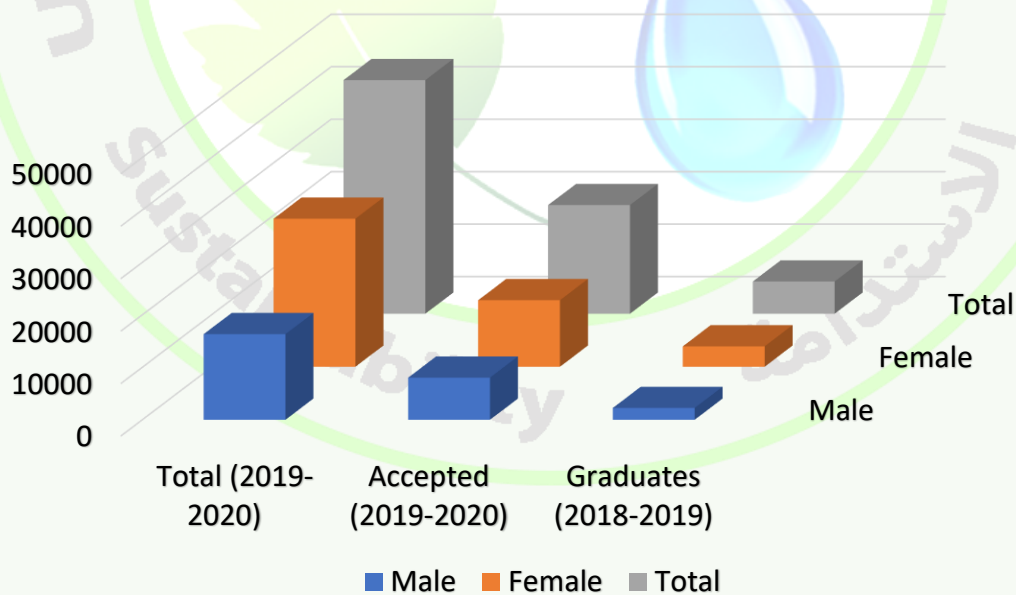



The statistic of the evening study students with charge for the academic year 2020 / 2021

Number of Students	Male	Female	Total
Total (2019-2020)	8648	5884	14532
Accepted (2019-2020)	3279	2417	5696
Graduates (2018-2019)	1034	800	1834

Statistics of the evening study students with charge for the academic year 2020 / 2021

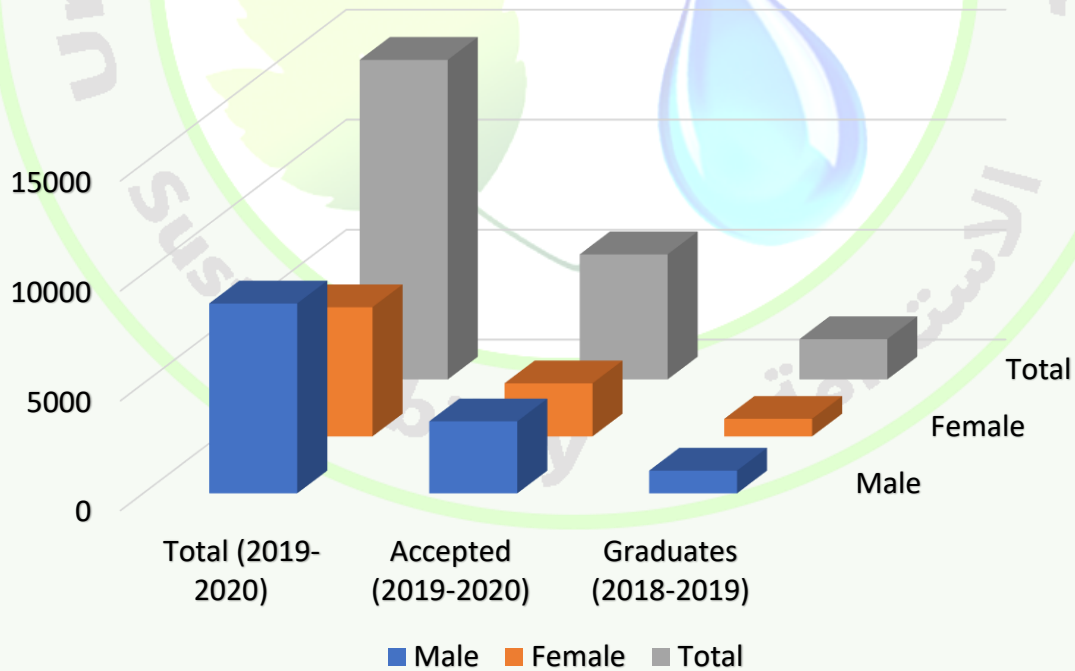



The statistic of Total students of the University of Basrah for the academic year 2020 / 2021 for both morning and evening study

Number of Students	Male	Female	Total
Total (2019-2020)	24962	34101	59063
Accepted (2019-2020)	11305	15094	26399
Graduates (2018-2019)	3278	4688	7966

Statistics of Total students of the University of Basrah for the academic year 2020 / 2021

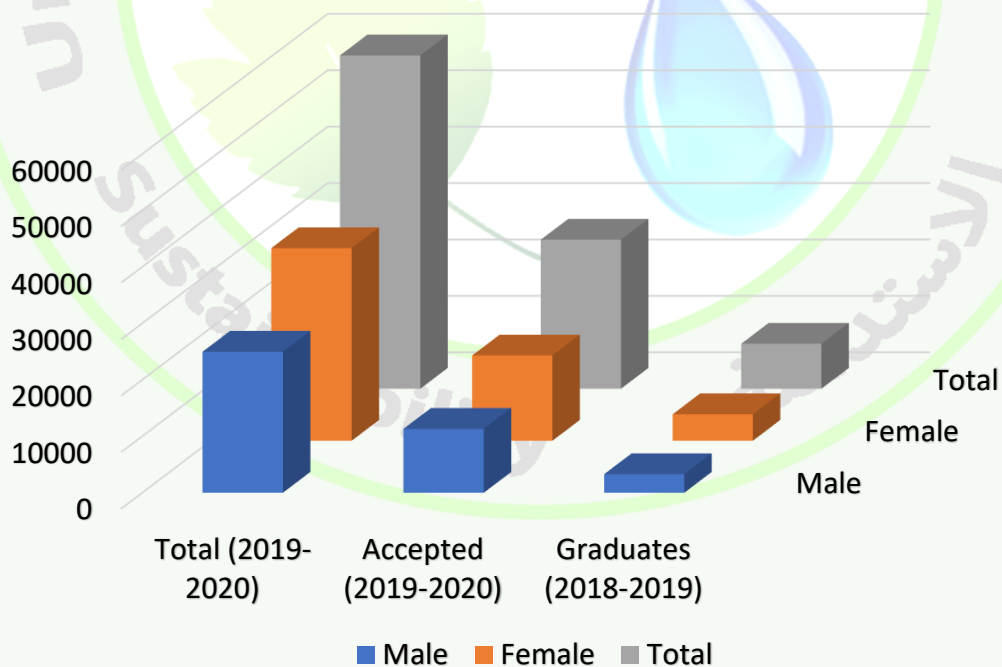



1.2.3 Number of lecturers and administrators

Assistant lecturer	lecturer	Assistant Professor	Professor	Total number of lecturers	Total number of administrators
520	838	776	510	2644	2208

The number of lecturers and administrators at the University of Basrah

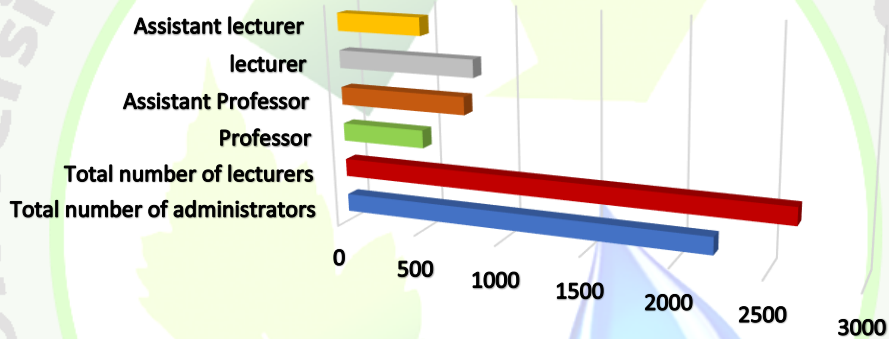

Percentage of teaching staff at the University of Basrah by scientific title

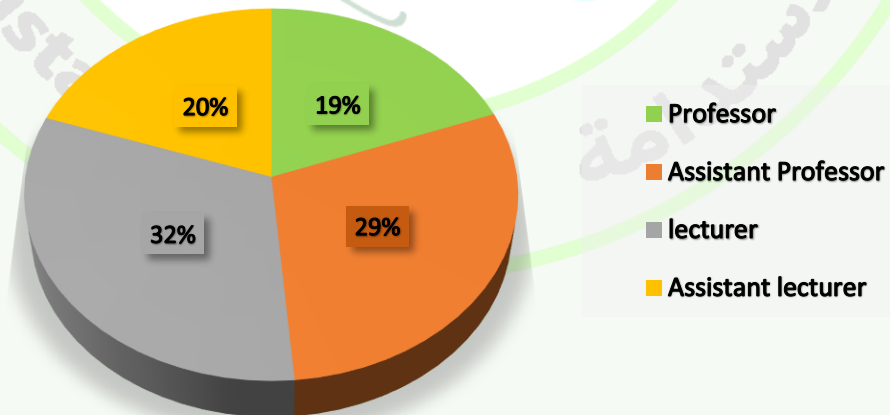



1.3. Campus Sites

Number of Colleges on the Site	5
Total Area of the Site	4,053,625 m ²
Total Area of Buildings	953,227 m ²
Open and Green Space Area	3,100,398 m ²
Ratio of Open and Green to the Total Area	76 %
Ratio of green space to the total area	30.20 %

The university of Basrah is looked upon as being the mother university for all public and private universities in the governorate of Basra, as it is the oldest university in the province. It provides its services to more than four million people with multiple specializations, which requires that the campus be spread in different strategic locations in the governorate to expand the scope of services provided by the university. The university contains five campus sites distributed in Basra governorate, as shown in the map below.

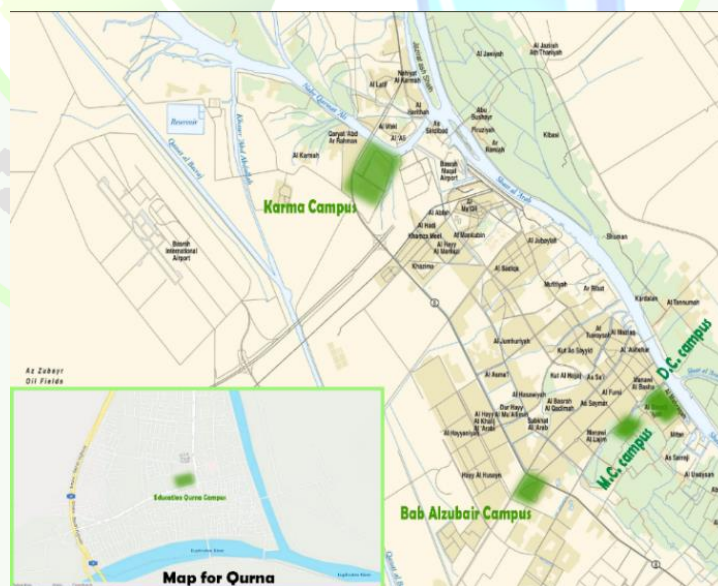



The university is currently heading to expand its campuses number by building new campuses in various locations of the governorate. Those campuses are Zubair, Shatt Al Arab, and Abu Al-Khasib. As a result, the total number of campus sites will be 8 campuses.

1.3.1 Bab Al-Zubair Campus

Number of Colleges on the Site	8
Campus Area	821161 m ²
The total area of buildings	295051 m ²
Open and green space area	526110 m ²
Ratio of open and green space to the total area	64%
Ratio of green space to the total area	40%





1.3.2 Karmat Ali Campus

Number of Colleges on the Site	9
Total Area of the Site	3,150,024 m ²
Total Area of Buildings	634,269 m ²
Open and Green Space Area	2,515,755 m ²
Ratio of Open and Green to the Total Area	80 %
Ratio of green space to the total area	27 %





1.3.3 Al-Bradeya Campus

Number of Colleges on the Site	1
Campus Area	35,500 m ²
The total area of buildings	11,284 m ²
Open and green space area	24,216 m ²
Ratio of open and green to the total area	68%
Ratio of green space to the total area	45 %

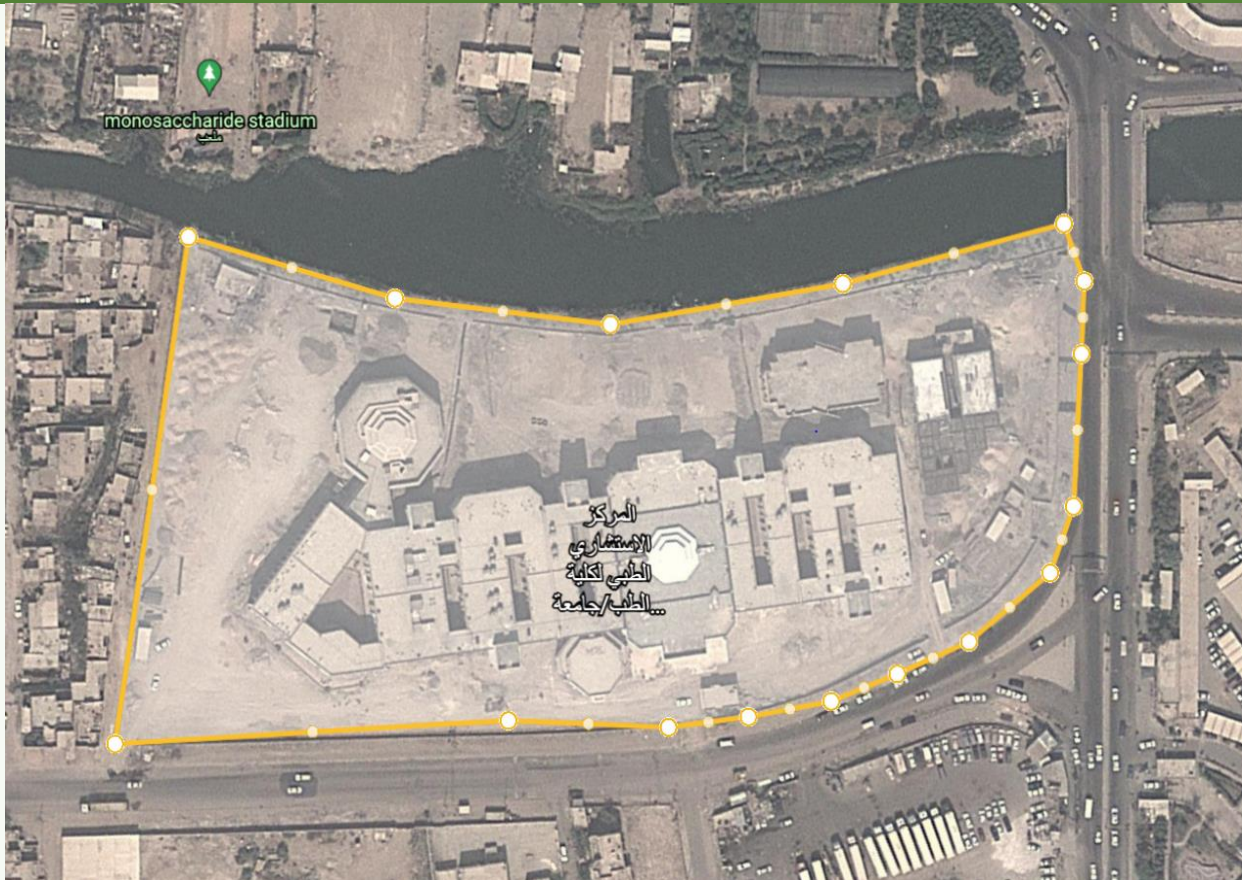



1.3.4 Al-Qurna Campus

Number of Colleges on the Site	2
Campus Area	37,500 m ²
The total area of buildings	8,150 m ²
Open and green space area	29,350 m ²
Ratio of open and green to the total area	78 %
Ratio of green space to the total area	40%

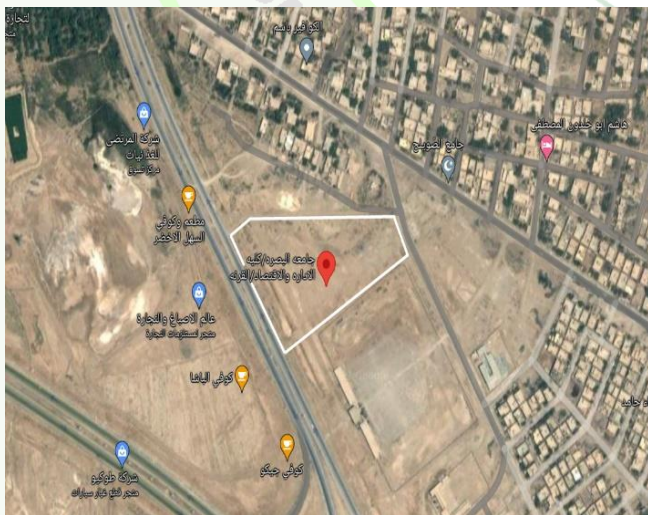



1.3.5 Dentistry Campus

Number of Colleges on the Site	1
Campus Area	9440 m ²
The total area of buildings	4473 m ²
Open and green space area	4967 m ²
Ratio of open and green to the total area	%53
Ratio of green space to the total area	30 %





1.4. Green areas

Part of the green areas at the University of Basrah:



UNIVERSITY OF BASRAH SUSTAINABILITY REPORT



All the agricultural areas of the university have a watering network and drainage systems to absorb water.



1.5. Essential Facilities On Campus

1.5.1 For Disable Special Needs And Or Maternity Care

The University of Basrah pays great attention to the community of people with special needs, whether they are from its affiliates, students, or visitors, and this is clearly appeared by providing basic facilities for public and personal uses.

1. Parking area The University provide several parking area in the garage for the people with special needs.





2. Easy Pass A special passages for walking to facilitate the movement of people with special needs which were constructed in every campus site in the university.

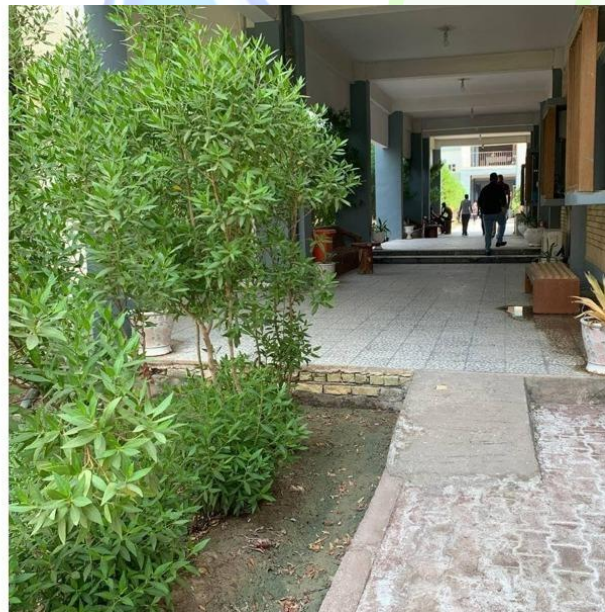



3. Facilities The university provides adequate sanitary facilities for the usage of people with special needs.





1.5.2 the maternity care



All government departments in Iraq, including the University of Basrah, adopt the Civil Service Law No. (24) of 1960 in Article (43) Paragraph (6), which guarantees to provide leaves to the employee or teaching staff which include after birth and antenatal until the end of childcare at the end of the first year. After the end of the first year, mothers return to their work within the University of Basrah, thereby the university provides nurseries for children in most of the university's faculties. With the beginning of the Covid 19 pandemic, all nurseries at the university stopped working according to the decisions of the crisis cell in Iraq. At the beginning of the 2021/22 school year, all nurseries went back to work with the observation of health rules, standards, and obligations relating to the Covid-19.



1.6. Security and safety

All University of Basrah facilities are subject to unified procedures to maintain security and safety on campuses.

1. Protection All main gates in the university campus sites are subject to the protection in corporation between administered by the University of Basrah and the Directorate of Facilities Protection in the province.



2. Fire Alarm In all campus sites, fire alarm devices have been installed to ensure rapid response in the event of a fire or emergency.



UNIVERSITY OF BASRAH SUSTAINABILITY REPORT

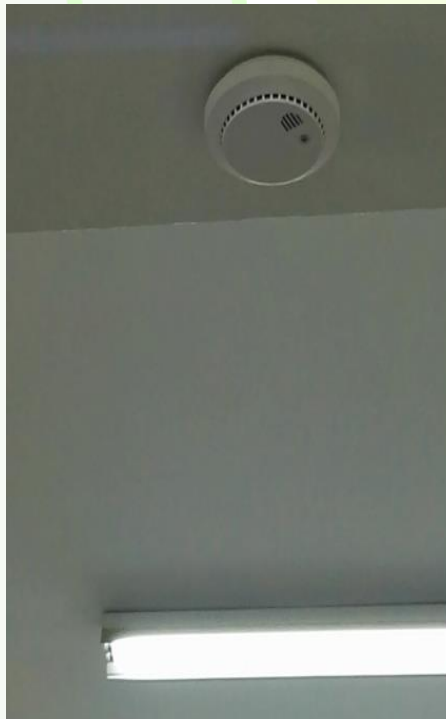



3. Fire Suppression system Fire bottle were distributed in all university buildings, according to the features of building and usage.







4. Monitoring Systems All buildings on all campuses are monitored by cameras to monitor all movements in those buildings.

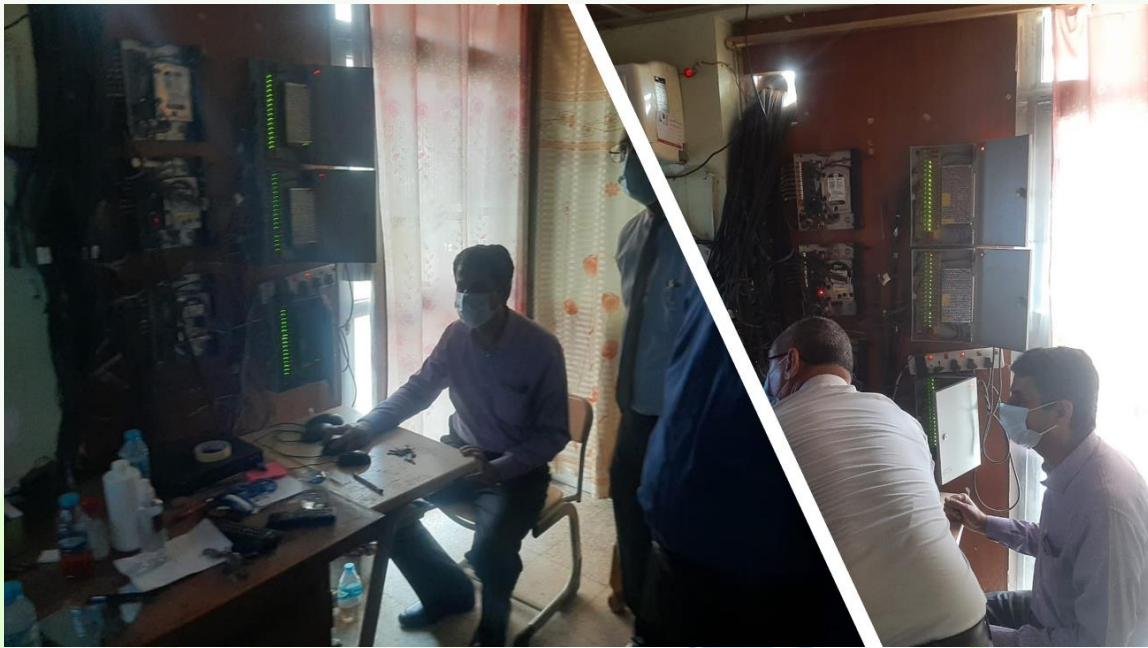

UNIVERSITY OF BASRAH SUSTAINABILITY REPORT

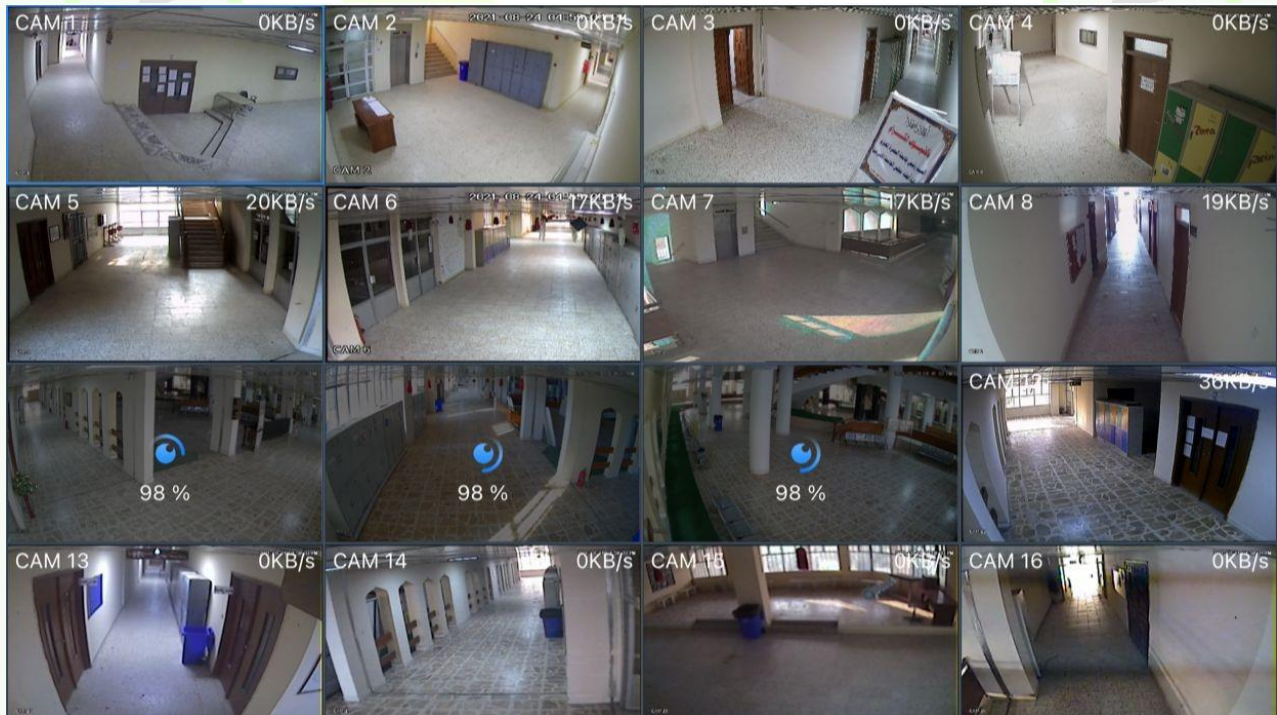



5. Emergency Signals All campus sites at the University of Basrah have emergency exits to ensure the rapid and safe evacuation.





6. Guiding All university buildings contain guiding posters which explains how to deal with emergency event based on the features of that building.



7. CBRN In cooperation with the Directorate of Civil Defense and the Chemical, Bacterial, Radiological and Nuclear Consequences Management Committee (CBRN) in Basrah Governorate, the University of Basrah CBRN committee has been established which has sub-committees in most of the faculties. Those committees provide training courses on how to face disasters, dealing with



effects, and performing many experiments on how to evacuate buildings rapidly in case of fires, as well as procedures for direct dealing with radiation leakage.



<https://sci.uobasrah.edu.iq/index.php/2020-03-06-07-44-02/2020-05-13-23-08-51/9209-cbrn.html>

1.7. Health infrastructure

The University of Basrah is characterized by containing several faculties of medical group colleges along with many health centers. The group of medical colleges in the university includes the College of Medicine which adopts the annual educational system, Al-Zahra College of Medicine, which adopts the integrative educational system, College of Dentistry, College of Pharmacy, College of Nursing, College of Veterinary Medicine, and College of Science which includes Analytics Department, Chemistry Department, and Life Sciences Department.



1. Medical Consultation Center The Medical Consultation Center, which is located on Al-Baradi'yah Campus / College of Medicine, provides a low price health services such as diagnosis and surgery under the management of specialists from the faculty of medicine for all citizens of Basrah governorate. The center also makes discounts for all university employees, teachers, administrators, and students.





2. Dentistry Clinics The University of Basrah has several dentistry clinics on all campuses, especially in the dentistry campus that is located in Al-Sadr Teaching Hospital. Under the supervision of specialists from the dentistry college, those clinics are utilized to train the students of faculty. At the same time, they provide specialized health services to the citizens and university members at subsidized prices.





3. **Psychiatric Clinic** A psychiatric clinic has been established at Al-Zahra College of Medicine for providing medical consultations through the counseling and psychological clinics which help the general community and the students who suffer from psychological problems to achieve the appropriate psychological and social adjustment.



Republic of Iraq
Ministry of Higher Education and Scientific Research
University of Basrah,
Al-Zahraa College of Medicine



جمهورية العراق
وزارة التعليم العالي والبحث العلمي
جامعة البصرة
كلية طب الزهراء

مشروع افتتاح عيادة الصحة النفسية والخدمات العلاجية النفسية
في جامعة البصرة

رسالتنا: (مجتمع واع صحياً)

مشروع مقدم من قبل: كلية طب الزهراء- جامعة البصرة
كخدمة للمجتمع

Edited by:
University of Basrah
Al-Zahraa College of Medicine

مقدم من قبل:
الطبيب الاختصاصي
د. هبة عبد الحسين

رئيس فرع الأحياء المجهرية
أ.د. حسين كاظم عبد السادة

الطبيب الاختصاصي
د. عباس جمعة

<http://zahra.uobasrah.edu.iq/students/advising-counseling>



4. Emergency The health center, located in Karmat Ali campus, provides free of charge health services to students and employees. Additionally, this center contains an emergency room and an ambulance for processing critical medical cases that require more specialized intervention.





5. Standardized Procedures In addition to health centers, the university provides standardized health procedures by the deployment of pharmacies containing the most important medicines and disinfectants in all university buildings, which are utilized for primary treatment until diagnosis by a specialized doctor.





1.8. Conservation of natural resources

The topographical feature of the Basrah governorate location is a fertile sedimentary area that is extended along the waterway of the Shatt al-Arab. The area is also characterized by environmental diversity due to the presence of water bodies that represent an extension of the marshes of Dhi-Qar and Maysan in the north along with Shatt al-Arab which is the river at which the Tigris and Euphrates are joined together. Shatt al-Arab is also discharged into the Arabian Gulf which has a view on south Basrah. The Arabian Gulf gives the advantage to Basrah for dealing with marine life. Finally, the western part of Basrah has a desert atmosphere. As a result, this makes the university of Basrah have a diversity in the scientific specializations in its colleges to cover this diversity in the climate, plants, living beings. Those faculties are agriculture college, marine science college, date palm research center, veterinary medicine college, and science college/ biology and ecology departments.

1. Incubators and greenhouses The University of Basrah own Incubators and greenhouses for the purpose of producing plants, in order to be used by the campus residents as food or for use as decoration and for planting university college gardens.



UNIVERSITY OF BASRAH SUSTAINABILITY REPORT







2. Cultivation of Fish The University of Basrah has a project of larvae fish Cultivation in fish lakes belonging to the University .





3. Grafting The University of Basrah has a project for Grafting trees and using cultivation methods that produce new strains of plants or preserve the species.





4. Contributions The University of Basrah has big contributions studying the aquatic environment such as preserving the life in marshes.





5. Animal husbandry Animal husbandry for food utilization and laboratory purposes.



مشاريع كلية الزراعة

UNIVERSITY OF BASRAH SUSTAINABILITY REPORT





6. Coral Reef Complex Coral reef found off the shore of Iraq, despite sediment and pollution, widens scope of country's biodiversity. For more information see:

<https://www.natureasia.com/en/nmiddleeast/article/10.1038/nmiddleeast.201>

4.62



7. In Iraq, Basra is the only city that has a sea port to the Arabian Gulf. This made the University of Basrah interested in research about such an important field. Therefore, the University of Basrah owns the Marine Sciences Research Center and the College of Marine Sciences, who share the study of the aquatic nature of the Shatt Al-Arab and the Arabian Gulf. The University of Basrah has two naval vessels that are used for the purpose of monitoring and studying the Iraqi rivers and waters from the Arabian Gulf, as well as specialized cadres and divers to enrich these studies.



UNIVERSITY OF BASRAH SUSTAINABILITY REPORT



Al- Abhath Boat



Nasim Al-Basrah Boat





1.9. Maintenance of university buildings during the pandemic

During the Covid-19 pandemic, all Colleges' buildings at University of Basrah were subjected to Maintenance activities. These activities were related to Cooling/heating systems, paths reconstructing, Medical Devices maintenance, etc.

1. During the Covid-19 pandemic, the cleaning teams exploited the curfew and cleaned all the University buildings. They also renewed and replaced some areas in the ceramic floors.
2. The cooling and heating systems have been maintained during the Covid-19 pandemic of the technical teams of our University. They also replaced several cooling and heating systems in the University.
3. During the Covid-19 pandemic, the technical teams of the University Maintained and fixed several medical devices at the Colleges of Dentistry, Medicine, and Alzahraa Medical College.
4. During the Covid-19 pandemic, the technical teams of University of Basrah exploited the absents of students in the beginning of Covid-19 pandemic and asphalted the internal street inside the campuses.



UNIVERSITY OF BASRAH SUSTAINABILITY REPORT



UNIVERSITY OF BASRAH SUSTAINABILITY REPORT

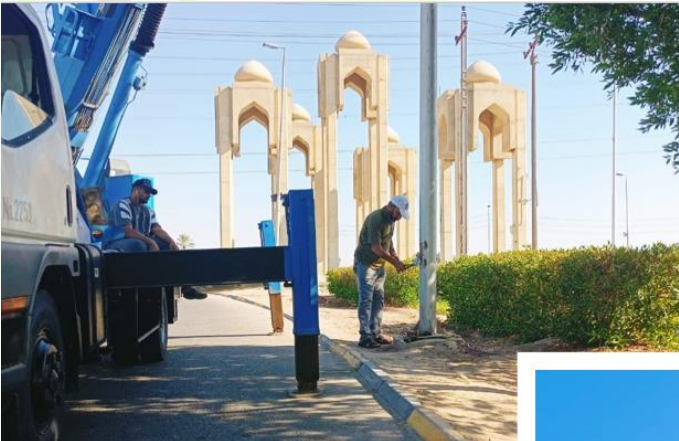

UNIVERSITY OF BASRAH SUSTAINABILITY REPORT





[2] Energy and Climate Change (EC)

2.1 Energy Efficient Appliances

Basrah governorate owns one of the largest power plants in Iraq. However, the connection of the electricity network in the governorate to the national network and the governorate's commitment to provide the rest of the governorates with specific electricity quotas made the governorate subject to programmed cuts. Therefore the electricity supplied to the governorate is insufficient to cover the demand of the governorate, so the university campus in Basrah University is subject to programmed electricity cuts, too. This necessitated the development of plans for the purpose of producing electricity during the cut's periods and rationalizing electricity consumption at the same time.

1. Rationalize the Consumption Changing all room and laboratory lamps in all campus buildings to energy-saving lamps, including LED lamps.

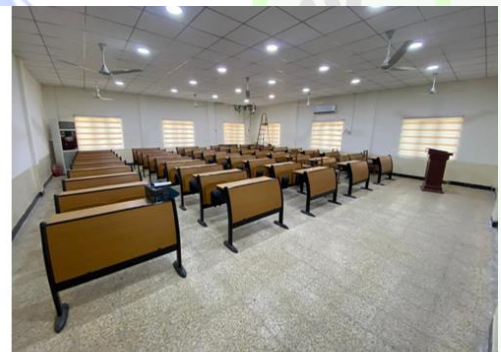



2. Auto on off lights: some university buildings contain a motion and light sensor, so the lights go out when the place is free of movement and lighting. Most of the corridors of the campus buildings contain a large number of glass windows, which allow sunlight to enter so that the sensor turns off the lights to rationalize consumption and extend the life of the lamps use, whereas in the evening and during evening study period, the lights are turned on automatically by sensing the movement of people in the corridor.





3. Energy Saving Devices: the university uses energy-saving devices (lights, fans and cooling devices) that work by charging during the period of non-use, for the purpose of using them when the power is cut off.



4. Diesel Generators: all University of Basrah buildings have diesel generators that are used in case of a power cut. The university has a trained cadre to manage these generators. These are also measures to rationalize electrical energy within the generators' operation capabilities.





2.2 Smart Buildings

The University of Basrah seeks to be one of the fourth-generation universities. In this regard, a part of the vision is to transform the buildings completely into smart management, and certainly, we aspire to reach this goal gradually. Currently, many procedures have been adopted at the University - under the supervision of the presidency of the university - which are considered steps towards the smart building.

- 1. Automation:** some university buildings have control over the lighting of the college via using programs designed for that purpose.

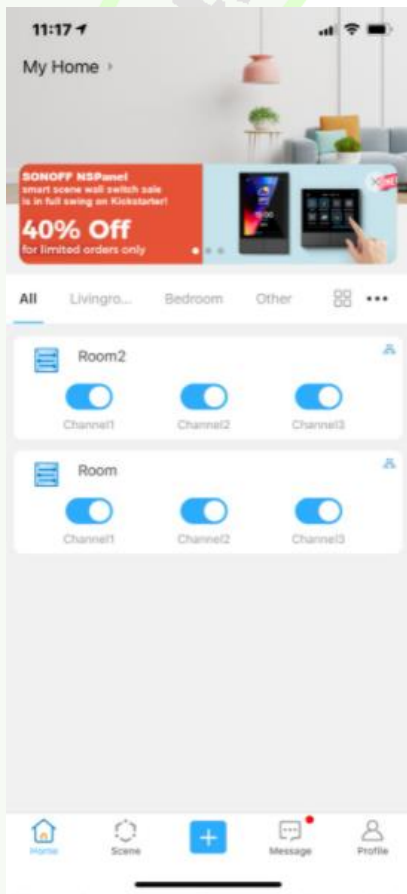



2. Safety:

- There is camera system in place to monitor all campus facilities, including buildings, classrooms, garages and gardens, to ensure complete control over all entrances, exits, halls and laboratories. The University has been upgraded in terms of using sound and motion-sensitive cameras to transmit sound between the control room and all building facilities and to give instructions for any movement. All cameras are connected to mobile phones so that the administrators and control room can continue to monitor at all times.

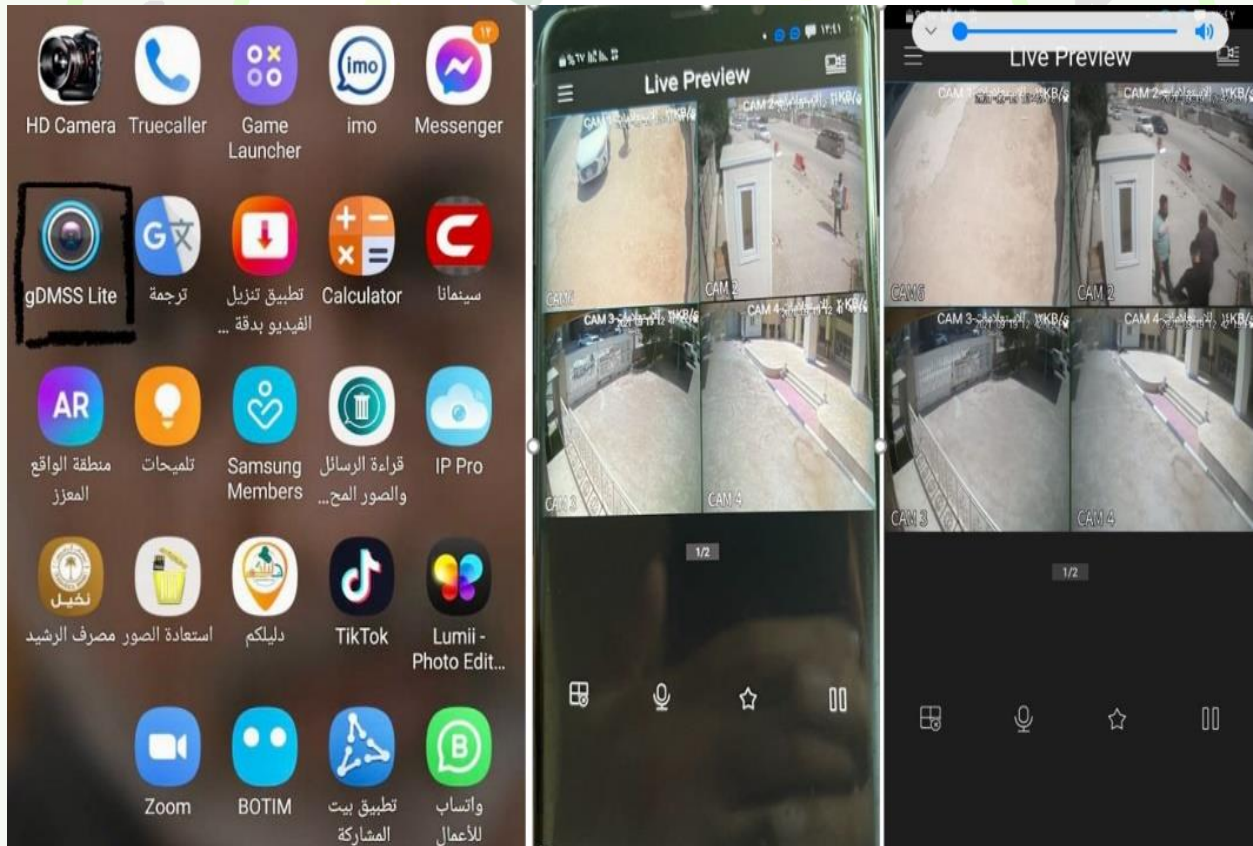

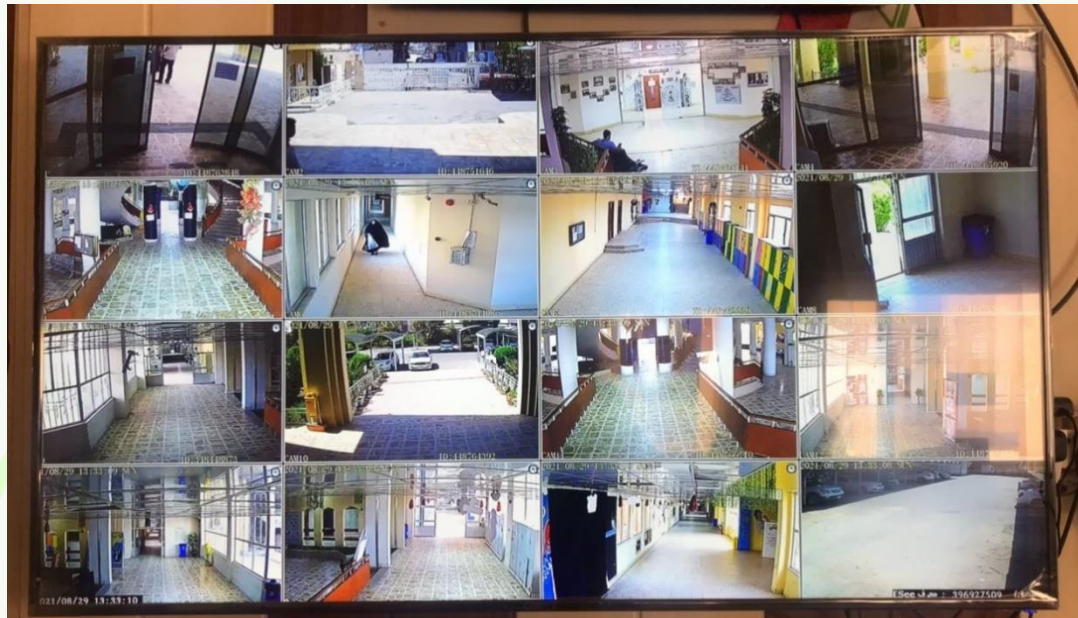

- Fire System: many buildings in the University of Basrah are equipped with a smart fire system. In those systems, as the sensors indicate any change in temperature, they send an email and calls to the responsible cadres to draw their attention that there is an abnormal situation and in the event of any fire breaking out, the system will work automatically to extinguish the fire.



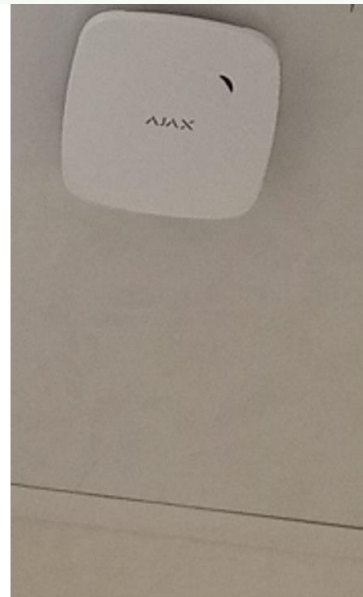
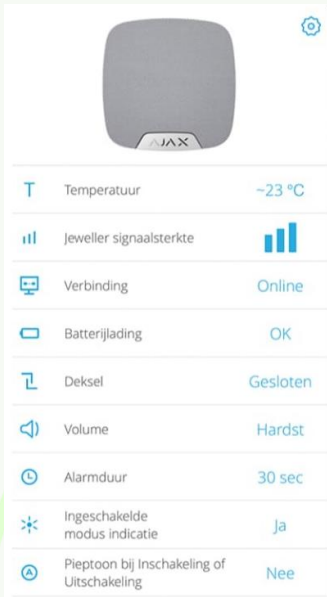

- Moving Detection Sensor Important places are equipped with a movement detection sensors, so only certain people are allowed to enter to those places. Those devices are also controlled remotely or using mobile phones.

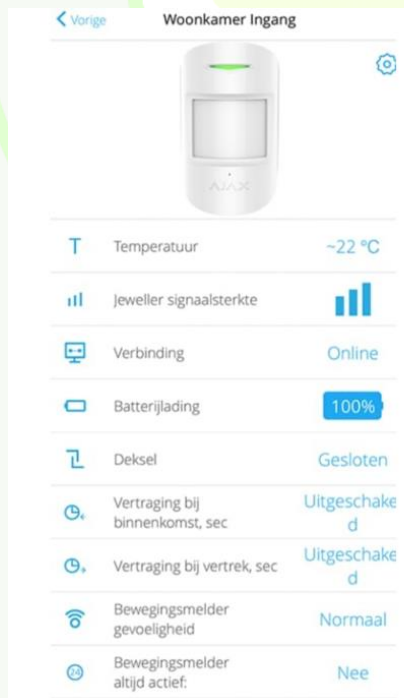



3. Energy: Solar panels The University of Basrah is characterized by the diversity scientific and literary disciplines, including the College of Engineering which has built an integrated and clean energy system that has been used to supply the college and its laboratories with clean energy.



Our cadres who work at the College of Engineering have invented a robot that can effectively clean the solar cells.





- 4. Smart Control of Natural resources:** the University of Basrah adopts a policy of gradual transition to smart control of all-natural resources. Some colleges employ the use of autonomous faucets for the rationalizing water consumption and at the same time reducing touching the faucets in laboratories and during the pandemic.



- 5. Air Purity:** COVID-19 pandemic has created a real need for the use of devices to preserve air purity in the university buildings. Thus, the corridors have been provided with air purifiers; and the university seeks to provide all buildings with devices that operate automatically for air purification.





6. Lighting Sensors: the University of Basrah follows a policy of upgrading all lighting in the university to smart lightings.

- rationalize electricity consumption by using light and motion sensors to regulate the lights turning on and off, which is considered one of the effective ways, as most of the campus buildings contain large and wide windows, which make lighting unnecessary during the day, so the lights are turned on in the evening with the start of the evening study. In unused rooms, the lights are turned off or on by sensing movement.



- Electricity Consumption: the university follows a policy of upgrading all lighting in the university to smart lighting, to rationalize electricity consumption by the gradual transition to using sun sensors (lighting sensors) and solar cells for the purpose of switching to using them in lighting streets and corridors at the university in the evening, as this is important to rationalize electricity consumption.





2.3 Renewable Energy Sources in Campus

The university is characterized by the diversity scientific and literary disciplines, including the College of Engineering which has built an integrated and clean energy system that has been used to supply the college and its laboratories with clean energy.





The University of Basrah also has clean energy production projects using biodiesel and that allowed the Ecology Department at the College of Science to produce electrical energy using bioethanol as an alternative biofuel to petroleum.



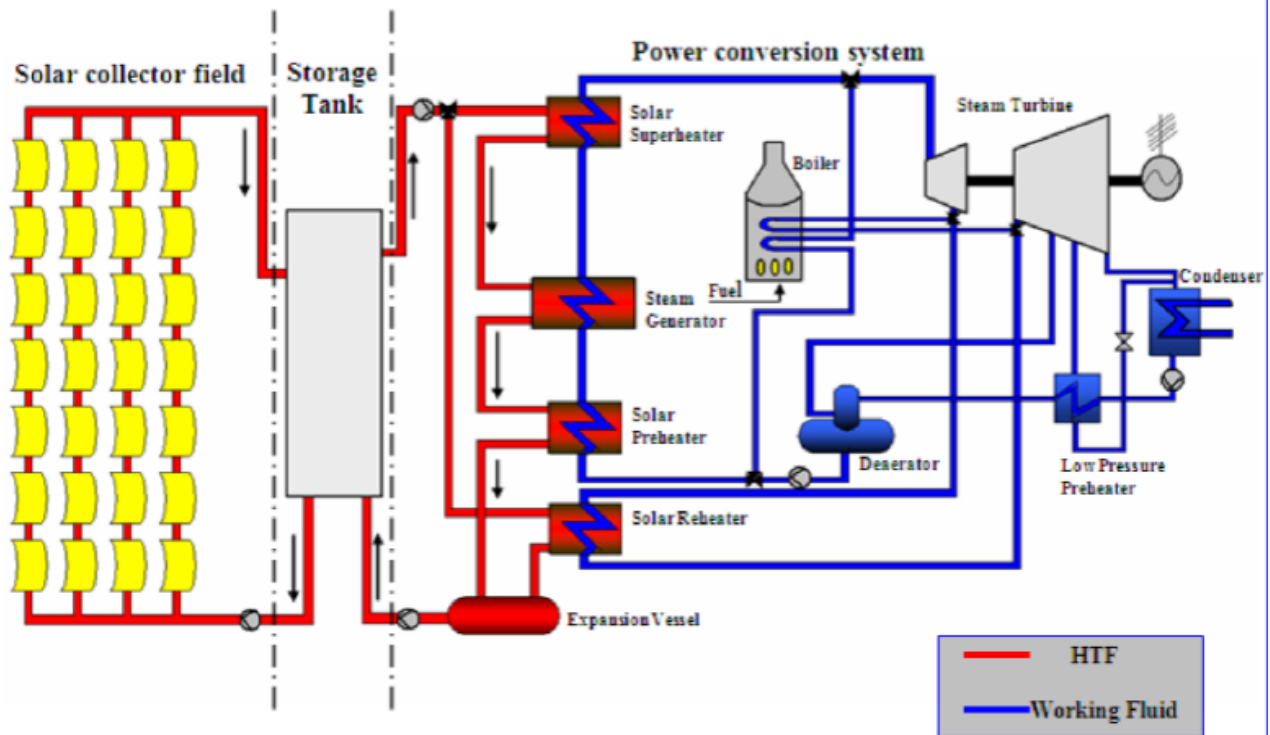

The university has researched the usage of the steam plant to produce clean electric energy. The boiler, turbine, condenser, and pumps represent the main part of the steam plant which is known as the steam pi plant. The second part is the solar thermal power plant, where steam is generated using the radiation of the sun instead of burning fuel in burners. In the above picture on the left, rows of concentrated solar collectors are shown that make the sun radiation concentrated at the water to obtain water vapor at High temperature and pressure to rotate the steam turbine, which in turn drives the generator. Other devices in the station are auxiliary devices such as the storage tank that contributes to storing the concentrated heat in the solar collectors, the super-heater, and others.



2.4 Green Building

based on the university calendar, the study period at the University of Basra extends from the fall, winter, till the spring. In general, the weather always is sunny with relatively little rainfall. Therefore, the architectural construction of all university buildings depends on the things that will be mentioned below

1. Large Windows Enlarge the windows size to allow sunlight entering the rooms, corridors and halls on the campus, as well as to ensure excellent ventilation of the buildings.



The buildings were designed to light through sunshine lighting rather than electric light to save energy. The images show the light of sun running through windows in the university buildings.

UNIVERSITY OF BASRAH SUSTAINABILITY REPORT





2. Ventilation and lighting All university campuses contain internal gardens to ensure ventilation, lighting, and warmth in winter



3. The College of Engineering was characterized by inventing devices that operate in an eco-friendly manner to be used in green buildings.
 - ✓ Cooling System: Eco-friendly cooling system has been designed to operate under outdoor conditions in Iraq.





<https://www.iasj.net/iasj/article/177145>

4. Fresh Water Production: a system was designed that combines both a solar diffuser with a ground-air heat exchanger and a solar chimney. The Solar radiation heats the water in the solar static pool, which heats in turn and humidifies the incoming dry air which turns into a stream air moving inside a tube due to the heating and mass transferring. When the wall temperatures of the glass tube and/or EAHE are less than or equal to the dew point of moist air, the vapor condenses into water and is used in a variety of applications. The maximum solar productivity still being achieved in March was 157 kg/day while it was 369 kg/day in July for EAHE the year 207.44 kg.

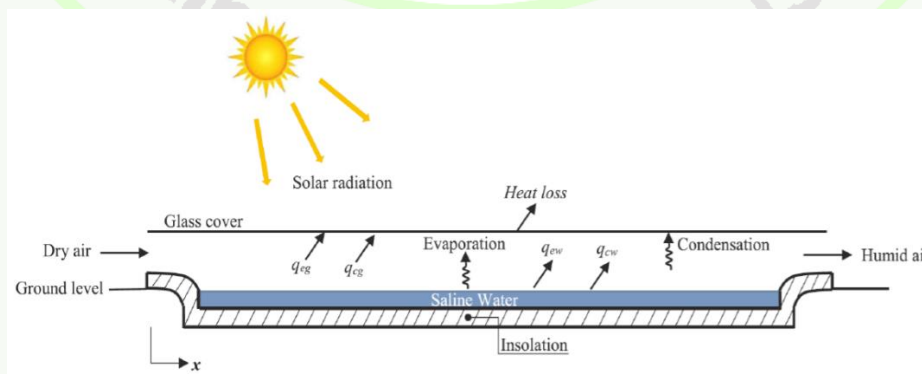
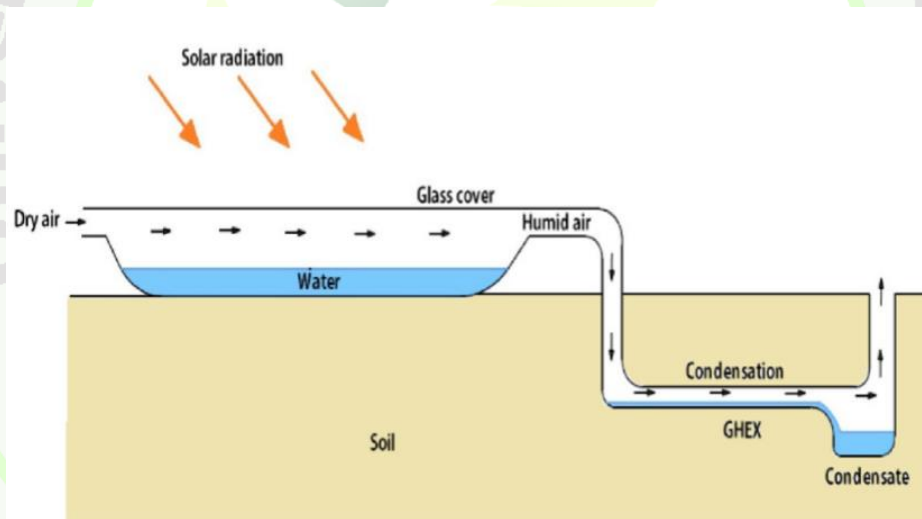



<https://www.tandfonline.com/doi/abs/10.1080/19397038.2021.1941392>

2.5 University's Greenhouse Gas Emission Reduction Program

University of Basrah design its own program to reduce global warming as a management method and for the campus in addition to the behavior of its staff. Below are the steps involved:

1. The university has specific parking area for students' cars in return for fees, which encourages students to travel in public transport cars or share private transportation with their colleagues. This is one of the policies followed to reduce the number of cars at the university.



UNIVERSITY OF BASRAH SUSTAINABILITY REPORT



2. The university directions were very clear in terms of using public transportation to travel around the campus in return for subsidized prices, which facilitate the transportation process, as well as reducing the number of cars at the university. This is one of the university's steps to reduce global warming.





3. The university do supply bicycles in the students dorms and zero-emission cars. Such a procedure contributes to reducing the use of cars in the university.



4. The existence of taxi mobile applications such as “Kareem” application, made it very easy to call a taxi instead of using private cars.





5. Using renewable energy contributes to the rationalization of electricity consumption, which helps reduce global warming.



6. The university's policy regarding rationalizing the use of electricity by using devices and methods is also considered as an influential means to reduce global warming.
7. The tendency to use environmentally friendly systems for cooling, water production and building designs all contribute to reducing global warming.

2.6 University programs impacting climate change

University of Basrah has many programs that have a positive effect on the climate

1. Air Pollutant Control: the University of Basrah own an air pollutant monitoring station which is located at the College of Science. This station is considered as one of the most important programs that contribute to monitoring the atmosphere in Basra Governorate. Since the Basrah coventrate is universally recognized as one of the biggest oil reservoirs city, the emitted gases result from the oil refining residues are the most air pollution factor. For example, this station contributes to explore the emission of black carbon and its impact on the atmosphere in the city.



it is also utilized by many research in the Department of Ecology/ College of Science to study the data extracted from the station.



2. Agricultural Support: the university attaches the utmost importance to agriculture, as it has launched several programs that support agriculture in all faculties of the university due to its importance in improving the climate. Most of the faculties in the university have private greenhouses and incubators for the cultivation and multiplication of special types of plants that are later used for cultivation in the college gardens Interior and exterior.



3. Agriculture Support Partnerships: one of the most important programs of the University of Basrah in preserving the climate and natural resources in the province of Basra is to devote all its potential and energy to forging partnerships. Such partnerships will serve this goal and focus on supporting agriculture. The university cooperates with the Dutch government / the Dutch organization for internationalization Education Nuffic, which is an independent, non-profit organization based in The Hague, Netherlands, which is active in promoting capacity building in developing countries. Entitled “Effective Water Management in Iraq through the Transition to Climate-Smart Agriculture: Capacity Building and Knowledge Development The project started in 2019 under the title”, the project was built to support sustainable development in Basra Governorate through the university. We attach a link to a lecture prepared about the project and the extent of the desired benefit From it by the University of Basra / College of Agriculture.

<https://drive.google.com/file/d/1DHBh5SrNld7Am6D6EnRjlrM7s3m5AlqP/view?usp=sharing>





We hope that after completing the project, which extends beyond Basra governorate as a beneficiary, the use of smart agriculture and reclaimed lands will contribute to changing the climate in the governorate.



<https://drive.google.com/file/d/1BxbYLrdb2NcFGw7GfhYXanMU5qQNir4L/view?usp=sharing>

2.7. The innovative program(s) during Covid-19 pandemic

From the first moment of the outbreak of the Covid 19 epidemic in the world, the University of Basrah began to form teams that worked in all directions for the purpose of helping the Iraqi society to confront the pandemic and had a distinguished role in all fields. We hope to be able to cover even a small part of what the university has accomplished as an educational institution with integrated disciplines for the purpose of helping the community to overcome the ordeal. In this part, we will discuss the programs innovated by the University of Basrah cadres in the field of energy and climate, and we will focus on the climate because the Corona virus is an air transmitted virus:

The First Innovation :



Due to the urgent need for continuous sterilization at the entrances of the university, especially the central laboratory at the College of Pharmacy, which was used to produce the carrier medium innovated at the University of Basrah and because of the borders were closed, importing was stopped, and complete curfew was imposed, our cadres designed a sterilization device at the main entrance of the central laboratory with a simple design to pass that time.



The Second Innovation :





After the success and operation of the fumigation devices at the university at the beginning of the pandemic, the University of Basrah directed to the supervision of equipping hospitals with ambulances fumigation devices and within a record time in cooperation with the engineering companies in the governorate, as well as providing them with fumigation solutions produced by the University of Basrah.

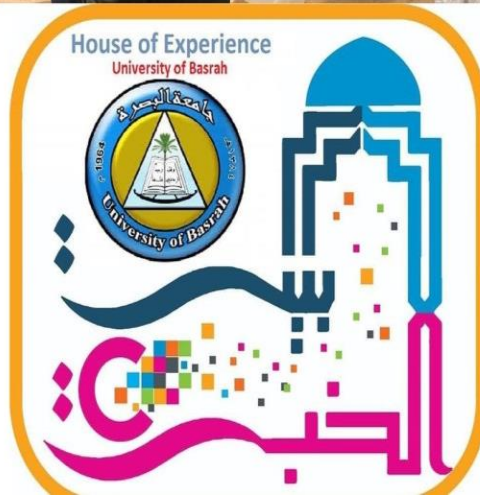

<https://www.uobasrah.edu.iq/news/250>

https://m.facebook.com/story.php?story_fbid=109635197446317&id=108693870873783&tn=%2As%2As-R

The Third Innovation :





Basrah Governorate, like all the governorates in Iraq, faced fears that its hospitals would not be able to accommodate the patients infected with the Corona virus, especially the providing ventilators with the closure of the borders and the closure of Iraq on what it has. The University of Basrah, with the capabilities of its cadres, has initiated the manufacture of ventilators with international specifications with an oxygen dispensing device to provide an integrated solution for providing clean air for Corona Virus patients in record time:

Technical Specification	
Screen size	• 15 inch Touch
Dimensions	• 60 x 60 x 160 cm
Weight	• 40 kg
Battery backup	• 9000 mAh @ 24V
Backup time	• 2 hours
Gas supply	• medical gas circuit system and/or oxygen
Alarm system	• Speakers
Network Connectivity	• Wired LAN and Wi-Fi 2.4GHz
Remote control	• Yes: smart phone or Windows/Linux machine
Maximum flow	• 120 L/min
Tidal volume	• Adult: 100 to 4000 mL • Pediatric: 20 to 350 mL
Maximum Inspiration Pressure	• 125 cmH2O
PEEP	• 0 to 50 cmH2O
Inspiration time	• 0.1 to 10 sec
Respiratory rate	• 1 to 100 b/min
Pressure Trig	• -0.5 to -20 cmH2O
Volume compensate	• 1 to 100 mL
Sigh Interval	• 1 to 60 min
Sigh Cycles	• 1 to 30
Pressure support	• 5 to 100 cmH2O
Ventilation modes	
V./A/C	• Volume Assist/Control
P./A/C	• Pressure Assist/Control
V-SIMV + PSV	• Volume-Synchronized Intermittent Mandatory Ventilation
P-SIMV + PSV	• Pressure-Synchronized Intermittent Mandatory Ventilation
PRVC	• Pressure Regulated Volume Control Ventilation
PRVC - SIMV	• Same As V-SIMV But Mandatory Ventilation Is PRVC Mode
PSV	• Pressure Support Ventilation Mode
CPAP	• Continuous Positive Airway Pressure

UBV 200 Ventilator

- Wi-Fi
- 15" TFT Detachable Touch Screen
- Integrated Power Supply Solution
- Built-in Battery

Basrah University
Basrah, Iraq
Tel: 00964- 780 101 2423
E-mail: ubv@uobasrah.edu.iq



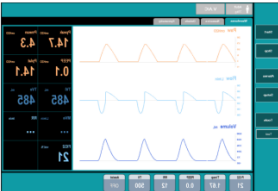

Monitoring

- Pressure waves: Pplat, Ppeak, Pmean, Pmin, PEEP
- Volume/Flow values: VT, VT_{max}, MV, MV_{peak}
- Time values: T_{exp}, T_{total}, IE
- FI_{O2}
- Compliance: MV/peak, RSB, WOB, I:E, Vdaw, PEEPi
- Pressure-Volume loop, Pressure-Flow loop, Flow-Volume loop
- High air and oxygen pressures monitoring

Main Features

- Automatic O₂ Calibration
- High function
- Volume compensates
- Alarm function for key parameters
- Remote monitoring and control
- Battery backup for 5 hours
- Monitoring of lung compliance and pressure-volume graph
- Monitoring of FI_{O2} in the inspired air
- Wide range of tidal volume 20 to 4000 mL
- Eight ventilation modes including assist, support and synchronized modes
- Large TFT display

Software Features

- Easy mode switching and parameters reconfiguration on the fly
- Easy mode switching and parameters reconfiguration on the fly
- Improved touch screen sensitivity
- Alarm sound mute for 5 minutes
- Alarm event log for 8000 events
- Self test and auto calibration/testing cases
- Unlimited number of patients, preset respiratory rate and supply pressure
- Alarm monitoring of tidal volume
- Easily configurable

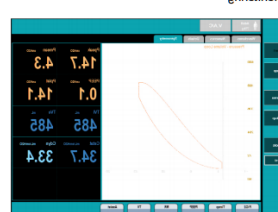

Superior ICU Ventilator

- Upgradable ventilation system software, with an available USB port
- Flexible device configuration with a unique metal-based compact, two hours capacity battery
- Comprehensive ICU ventilator including V.A.C, P.A.C, V-2IMV + P2V, P-2IMV + P2V, PRVC, PRVC - 2IMV, P2V and CPAP
- It treats adult patients with all acute levels at ICUs and Intermediate Care
- accurate timing
- The microprocessor controlled operation ensure high sampling rate and versatile in use. The ventilator first's simple to configure, easy to operate, and



<https://uobasrah.edu.iq/news/510>

<https://ninanews.com/Website/News/Details?Key=823640>

<http://basra.gov.iq/ar/index.php/permalink/26219.html>

<http://arabicradio.net/news/54670>

<https://www.uobasrah.edu.iq/index.php/news/133>

<https://www.uobasrah.edu.iq/index.php/news/773>

The Fourth Innovation :

The building of the University of Basrah presidency is one of the largest buildings in the university vertically, which did not stop providing its services to all the university formations and receiving the visitors, and this posed a danger to all its members. The presidency recorded the most Corona Virus infections among the



total number of inventions for all the university formations. This generated a challenge to purify the indoor air in the building to provide a healthy atmosphere suitable for work for members of the Presidency of the University and visitors at the same time. Therefore, the University of Basrah took the initiative to design air purifiers that operate automatically and provided them with automation devices to turn them on and off from a distance





[3] Waste (WS)

3.1 Recycling Program for University Waste

As an educational and research institution that keeps pace with the global and international trend towards sustainable living, which will ensure the sustainability of life, the University of Basrah has developed its programs that will ensure that this goal is reached and implemented. One of the most important fundamentals of sustainable living is how to deal with waste and make the most of it by recycling it within what is possible and available. Therefore, the University of Basrah gave special attention to developing programs that ensure the recycling of university waste and benefit from it. We summarize the most important procedures as follows:

1. Classification of university waste is the most important step in the program, because the methods of dealing with waste varies and changes according to the type of waste.





2. Waste The most waste types that can be recycling in the university are paper, plastics, metal, Aluminum, glass, organic material, etc.



3. non-recyclable waste The local government in Basrah eliminates the non-recyclable waste from all campus buildings at the University of Basrah.





4. Wastes Recycling The University of Basrah has a plastic waste treatment units for recycling all types of wastes; and thus utilizing it in paper manufacturing and other light purposes.



5. University of Basrah/College of Science/Environment Department established the Environmental Treatment Laboratory to provide an opportunity for postgraduate and undergraduate students to work in the field of treating various organic environmental pollutants and heavy metals. The idea of the laboratory focused on using environmentally friendly methods to get rid of organic pollutants such as removing crude oil, its derivatives and heavy metals from water and soil through the use of aquatic plant species such as reeds, papyrus and Ceratophyllum and terrestrial plants such as barley.



The laboratory works within several axes, including:

- ✓ Phytoremediation of soils contaminated with petroleum hydrocarbons using three types of plants.
- ✓ Studying the role and physiological and anatomical changes of some aquatic plants exposed to oil pollution.
- ✓ Using the papyrus plant to reduce water kerosene pollution.
- ✓ Treating industrial water for the Najibiya electric plant by using some plants.

2.3 Program to Reduce the Use of Paper and Plastic on Campus

The University of Basrah adopts a strict system for all campus sites which aims to reduce the use of paper and plastics

1. Paper Usage In all its works, the University of Basrah uses the paper on both sides manner and reusing the paper that has been used on one side to use the other side. Furthermore, all wastepaper is collected for later reuse.



2. Paper Recycling The University of Basrah has cooperated with the Ministry of Industry and Minerals / Basrah Paper Factory for receiving and recycling all paper waste that was used by all colleges and centers in the university. Then, that factory sends the new paper to the university. This step is one of the important plans in the university to reduce the use of paper.





3. Paper Envelopes Most of the faculties in campus use paper envelopes instead of plastic folders to reduce the usage of plastic in any official transactions in the university.



4. Paper Usage Reduction The university heads towards digital transformation progressively to reduce the paper-based official transactions by launching platforms that allow those transactions such as SIS and HR platforms. The university has also launched the blended education portal, which aim to manage the education process digitally.





3.3. Organic Waste Treatment

The University of Basrah supports all projects submitted by the faculties regarding treating organic waste that results from laboratory actions and other educational work. Therefore, the faculties of the University of Basrah have provided specialized units for the disposal of organic waste in all faculties.

1. Medical Waste Waste treatment devices were developed to get rid of the waste result from the clinical medical education in the College of Medicine, especially the waste in the anatomy and pathology departments.

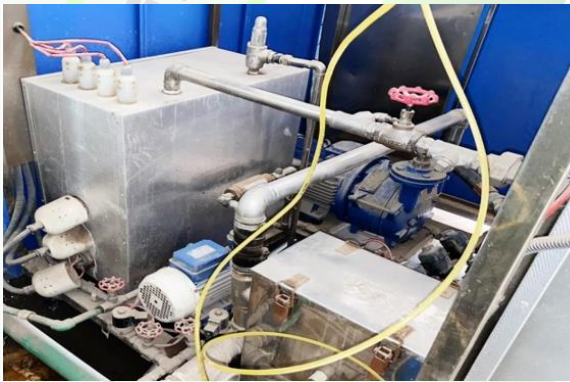

2. Animal Waste The College of Veterinary Medicine uses the organic waste treatment units to treat with the animal waste that have been used in autopsy and laboratory experiments.





3.4 Inorganic Waste Treatment

The University of Basrah has launched an initiative of directed electronic waste and electronic devices WEEE. This project aims to collect all inorganic materials from non-repairable electronic devices and dismantling them to reuse the valid parts to repair other repairable devices.



Most of the university's facilities have established internal workshops for recycling electrical waste.







3.5 Toxic Waste Treatment

All laboratories in the University of Basrah are subject to surveillance of the usage of toxic substances, whether it was a chemical, biological, radiological, or nuclear substances. The university has strict procedures for dealing with the toxic waste. As all toxic substances are registered with the Chemical, Bacterial, Radiological and Nuclear Consequences Management Department (CBRN) in the Civil Defense Directorate, and they are dealt with as follows.

1. These materials are stored, according to type, in special rooms and laboratories equipped to deal with such materials.
2. Getting rid of of these materials with strict approvals, and the CBRN committee in the college is informed about the changes in the quantity of those materials.
3. Laboratories that deal with radioactive materials are periodically subjected to a strict monitoring about the level of radiation is monitored, and workers in such laboratories are examined.
4. The CBRN sub-committee in each colleges cooperates with the CBRNE department in the Civil Defense Directorate in the governorate to deal with toxic waste.

As for the toxic waste resulting from the educational and laboratory process in in medical group colleges, the process of getting rid of all kinds of germs is also done by killing with autoclaves, while the rest of the materials are disposed of in an incinerator.



<https://youtu.be/Ym6ayComRc>



3.6 Sewage Disposal

Basrah governorate is undergone to a sewage network, thereby all sewage water is purified by removing the suspended solids and converted to effluent before being discharged back to the environment outside the governorate. Since the University of Basrah is an educational institution that is concerned with scientific research and maintaining a sustainable living, the University of Basrah has paid attention to sewage disposal, especially the governorate faces a serious problem on such matter due to the high salinity in the Shatt al-Arab and the water pollution.

1. Recycling Water To rise the innovation and creativity, the university has launched a wastewater recycling project that has been designed and manufactured by its own cadres



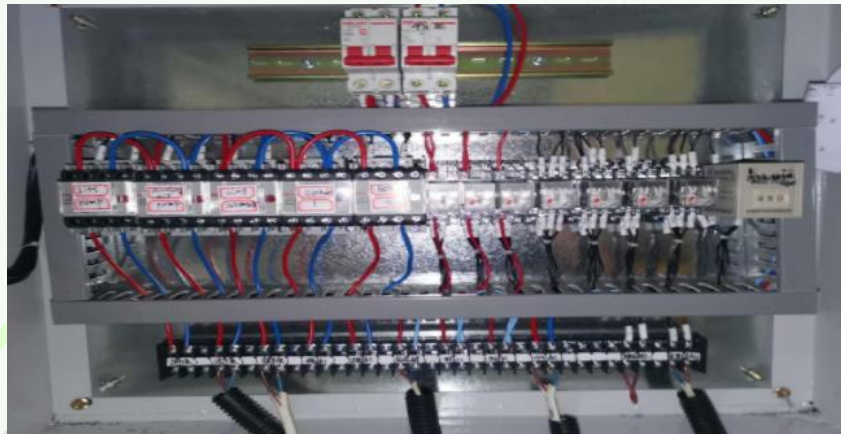

2. The Usage of Recycled Water The treated water is then utilized to watering the green spaces on each campus



3. Non-Recycling Water The wastewater that is resulted from laboratories and clinics is treated before being discharged into the sewage network near the university campus.





[4] Water (WR)

4.1 Water Conservation Program

The University of Basrah is the oldest in the southern region of Iraq, as the university buildings are designed to meet the standards of an educational institution building. Certainly one of the most important building standards is the washing water network, the sewage network, and the network of rainwater drainage from all the rooftops of the university buildings. As the climate of the governorate is relatively humid, in addition to the abundance of water in winter.





Each university campus has a different design according to the nature of the area in which it is located, so the rainwater drainage network varies according to the location of the campus. For example, each of Karmat Ali campus, the College of Medicine campus, and the Qurna campus are located in an area characterized by being close to rivers, and because the open and agricultural areas in it are vast, so rainwater is directed to those rivers or the surrounding agricultural areas while diverting some of the rainwater into the sewage network.



The University of Basrah adopts the same policy followed in all public buildings, the principle of storing washing water in large and numerous tanks for later use because it is subject to specific pumping periods. The tanks are placed on the rooftops of buildings to give pumping speed to all floors of the building, and certainly, because the water pumping is at certain times of the day, so the university uses taps with low water flow in each of the bathrooms, sanitary facilities, and washbasins, as well as using a policy of regulating the use of water in sanitary facilities using control devices that stop the flow of water when the tank is full. We aspire to expand the use of automatic stop taps to reduce the use of clean water.



The university owns rainwater reservoirs, which are used to water agricultural crop and animals. The university owns many desalination and distillation stations for the purpose of self-sufficiency with drinkable water and distilled water for laboratory use.





Desalination Basrah Governorate faces a serious problem, which is an increase in water salinity during summer, due to incorrect policies used by neighboring countries to reduce water allocations of Iraq because they have the tributaries of Iraqi rivers, which led to a decrease in water levels in Shatt al-Arab and a rise in the salt wedge from the Arabian Gulf towards Shatt al-Arab, making its water undrinkable. Salinity changes from year to year due to the amount of rain falling on Iraq during the rainy season. The University of Basrah, as an educational institution, has presented many studies and research in this field. It has also adopted a project to install desalination plants to produce sterile RO water, which is completely consumed in drinking and research uses.



The above images are distillation stations of the University of Basrah.

4.2 Water Recycling Program

The University of Basrah adopts a clean drinking water liquefaction network that is completely isolated from the sewage network.



Water Recycling Within the initiatives of the University of Basrah to support innovation and creativity, the university launched a wastewater recycling program, designed and manufactured by its cadres. The treated water is used to water the greenspaces on the university campus. The device in the beside picture is used for this purpose.

4.3 Water during Covid-19 pandemic

The University of Basrah has its own way of using water during the Covid 19 pandemic, which has contributed to reduce infection and the spread of disease.

1. **Awareness Programs:** The University of Basrah continuously launches awareness campaigns on the necessity of washing and sterilizing hands to avoid infection or transmitting of the virus.



CORONAVIRUS فايروس كورونا

ما هي طرق الوقاية من الفيروس

- المقاومة على غسل اليدين جيدا بالماء والصابون أو المواد المطهرة الأخرى التي تستخدم لغسل اليدين خصوصا بعد السعال أو العطس
- استخدام المنديل عند السعال أو العطس والتكلم عنه في سلة النفايات ثم غسل يديك جيدا وإذا لم يتوفر المنديل فاستخدم أعالي الذراع وليس اليدين
- حاول قدر المستطاع تجنب ملاصقة العينين والأنف والفم باليد، فاليد يمكن أن تنقل الفيروس بعد ملامستها للأسطح الملوثة
- إبقاء الكمادات في أماكن التجمعات والأجنحة
- تجنب قدر الإمكان الاحتكاك المباشر بالمصابين ومشرفيهم في أدوارهم الشخصية
- المحافظة على النظافة الشخصية مع الحرص على نظافة الأسطح والأثاث
- المحافظة على المعدات الصحية الأخرى التورن الغدائي والسفاح البدني واخذ قسط كاف من النوم

اعداد / قسم العلاقات العامة والاتصال في جامعة البصرة

جامعة البصرة كلية القانون

نصائح مهمة لتجنب الإصابة بفيروس «كورونا»

غسل اليدين مرارا وتكرارا كل 20 دقيقة

تجنب ملامسة حيوانات المزارع والبرية

عدم مخالطة المصابين بالتهابات تنفسية حادة

تجنب الاتصال الوثيق مع الآخرين مثل العناق والقبل

تجنب الاتصال الوثيق مع الناس الذين يعانون من المرض

تجنب لمس عينيك أو أنفك أو فمك بأيدي غير مفضولة

غطي فمك وأنفك بمنديل ورقي عند السعال

2. **Water Desalination:** The University of Basrah owns several water desalination systems. However, during the pandemic, The university was adding and rehabilitated more water desalination systems to meet the university's need for clean and sterile water to be used as part of sterilizer production projects. The most important desalination project is located at the university hostel.





3. **Washing Hands:** Some campuses in the university utilizes outdoor sinks for washing hand.



4. **Vehicle Disinfection:** The University of Basrah cadres was able with personal efforts to create disinfection rooms for people and cars. Additionally, a disinfecting room for disinfecting ambulances was donated to the Basra Health Department.





5. **Sterilization Rooms:** The University of Basrah Prepared the entrances of its colleges, centers, and units on the university campuses with sterilization rooms.



6. **Sterilization Materials:** The health-related colleges have competed with each other for preparing the sterilization materials with a concentration of 7% utilizing the sterile water that is provided by the university with a ratio of 30% to use those materials in buildings sterilization at the university campuses, not to mention, providing those materials to several organizations in the Basrah governorate.





7. **Spraying Buildings:** The field service personnel periodically cleans and sterilizes all the buildings at the campuses to restrain the spread of the pandemic.

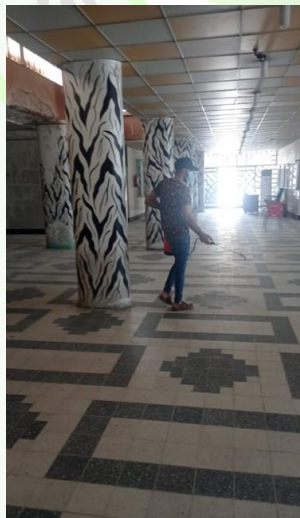



8. **Sterilization Stands:** The University of Basrah has distributed stands for sterilizing and washing hands in all buildings on the campuses.



[5] Transportation (TR)

5.1. Mass Transport Services

The University of Basrah has provided transportation inside and outside the campus for students and employees.

5.1.1. On-campus transportation service

The Transportation Department transports students and employees from a place designated for parking to their colleges, and transport students from the dorms to their colleges located inside the university site and vice versa.

UNIVERSITY OF BASRAH SUSTAINABILITY REPORT



A map of the transportation route inside the university campus.





5.1.2. Off-campus transportation service

The Transportation Department transports students and employees from most districts of Basrah Governorate, where it works on the distant districts, in addition to transporting students of the dorms to their colleges that are located outside the university site, such as the College of Medicine and Dentistry, the College of Administration and Economics for Girls and vice versa.

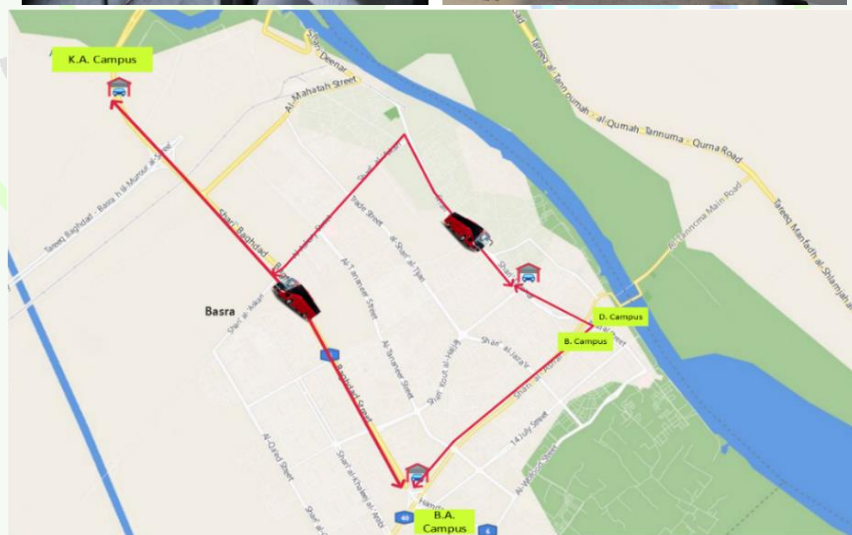

Off-campus transportation route map



6.1.3. Statistics for the total number of cars (cars and motorcycles) inside the university campus

1	Number of Campus cars	46
2	Number of Cars entering the university campus	881
3	Number of Motorcycles entering the campus	250
4	Total number of on-campus vehicles	1177

**Total no. of on-campus vehicles / Campus population=1177/27117
= 0.043**

5.2. Zero Emission Vehicles (ZEV) Policy on Campus

5.2.1. Electric Vehicles

University of Basrah has equipped the Bab Al-Zubair campus with electric-powered vehicles in cooperation with Imam Ali Holy Shrine, to facilitate the movement of visitors and students inside the campus, especially since the Garmat Ali campus has mass transport buses for the purpose of reducing the environment polluting emissions inside the university campus.



7 العتبة العلوية المقدسة
قسم صيانة الآليات والمعدات التخصصية
وحدة الاستثمار

مواصفات عجلات الشحن
SPECIFICATIONS OF CARGO WHEELS

Model 72 V	Model 48 V
MOTOR	
Rated Power: 5 KW	Rated Power: 4 KW
Rated Voltage: 72 V	Rated Voltage: 48 V
Rated Current: 84 A	Rated Current: 101 A
CHARGER	
Input current: 11A	Input current: 9A
WT 7225ZLCF	WT 4825ZMB
Rated output voltage: 72 VDC	Rated output voltage: 48 VDC
Battery 6V220AH	Battery 6V220AH
D.C. MOTOR CONTROLLER	
VOLTAGE: 60-72V	VOLTAGE: 36-48V
CURRENT: 500A	CURRENT: 500A

15 العتبة العلوية المقدسة
قسم صيانة الآليات والمعدات التخصصية
وحدة الاستثمار

This image shows the specifications of the charging cars equipped for the University of Basrah.



5. 2. 2. Bicycles

To reduce the environment polluting emissions, in addition to reducing the number of vehicles parking spaces, the University of Basrah has provided a number of bicycles for its students to use them to move around the campus.





5. 3. The ratio of the parking area to the total area of the campus

Campus Site	total area of the campus m.sq	Total parking area m.sq	Ratio of the parking area to the total area m.sq
Garmat Ali	3150024	63426	2.0%
Bab Al-Zubair	821161	21067	2.5%
Medicine	35500	2245	6.3%
Dentistry	9440	623	6.6%
Al-Qurna	37500	928	2.4%
University of Basrah	4053625	88505	2.1%



5. 3. 1. On-campus parking area ratio for Garmat Ali Campus.

The chart below shows the ratio of parking area to the total campus area in Garmat Ali campus.



5. 3. 2. On-campus parking area ratio for Bab Al-Zubair Campus.

The chart below shows the ratio of parking area to the total campus area in Bab Al-Zubair Campus.





5.3.3. On-campus parking area ratio for Al-Baradiyah Campus/ College of Medicine

The chart below shows the ratio of parking area to the total campus area in Al-Baradiyah Campus/ College of Medicine.



5.3.4. On-campus parking area ratio for Al-Baradiyah Campus/ College of Dentistry

The chart below shows the ratio of parking area to the total campus area in Al-Baradiyah Campus/ College of Dentistry.





5.3.5. On-campus parking area ratio for Al-Qurna Campus

The chart below shows the ratio of parking area to the total campus area in Al-Qurna Campus.



5. 4. University policy to reduce on-campus parking areas

The University of Basrah campus is subject to a consistent policy regarding the entry of vehicles into the university campus, and we can summarize it as follows:

1. Vehicles are not allowed to enter the university campus without a permit from the Permits Department at the University Presidency. As all the vehicles of the university's employees, including teaching staff, administrators and technicians, are subject to scrutiny to enter the campus.
2. Only employees are allowed to use the in-campus parking areas, and the students parking area is outside the colleges of the university campus.
3. Students are allowed to use the parking areas allocated to them in return for fees collected by the university from the renting individual. This is one of the steps



taken at the University of Basrah to maximize resources and at the same time to encourage students to use public or private mass transportation.

4. The university provides public transport buses and zero-emission cars that roam the main streets throughout the day for the purpose of facilitating the movement of students on campus.
5. The university provides a parking area for bicycles near the university dorms to provide transportation within the university campus, and this is one of the important steps to reduce emissions at the university.
6. The availability of a taxi application in Basrah Governorate, such as the Karim application, enabled many students and employees to get a taxi quickly and smoothly, which reduced the use of private cars on the university campus.

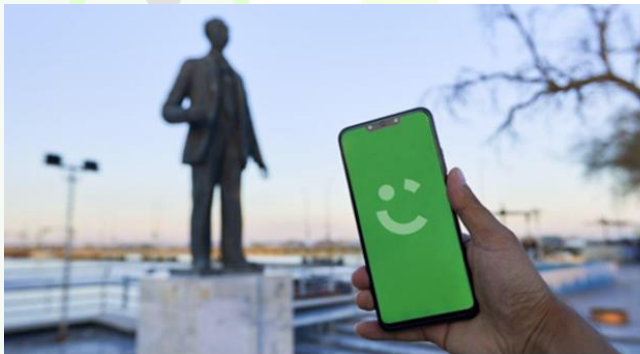



5.5. Campus Pedestrian Path Policy

The University of Basrah follows a strict policy of separating pedestrians from vehicles, as vehicles are strictly prohibited from traveling within the pedestrian spaces in the colleges of the university campus. The use of vehicles is restricted to the main roads on campus only, so that there is no contact between pedestrians and vehicles.



The university provides special pathways that take into account people with special needs.



The university uses solar energy for night lighting.



5. 5. 1. Garmat Ali campus pedestrian path





5.5.2. Bab Al-Zubair campus pedestrian path



UNIVERSITY OF BASRAH SUSTAINABILITY REPORT





5.5.3. College of Medicine campus pedestrian path





5.5.4. College of Dentistry campus pedestrian path





5.5.5. Al-Qurna campus pedestrian path





[6] Education and research (ED)

6. 1. Subjects related to sustainability at University of Basrah

The table below represents a list of courses that include sustainability within its vocabulary, describing the sustainability of the curriculum.

	Courses/subject	College related	Description
1	Human Rights course	Compulsory Course in all Colleges in the University of Basrah in First stage In 21 colleges involved by about 15000 students each year.	Describe the human rights determinations and Amnesty international organization. The course clarifies the human right to live with dignity and without racial, ethnic, sectarian or gender discrimination. It sheds light on the government laws and determination that protects human rights.
2	Fundamental of Ecology	Compulsory Course In 1 st stage at College of Science University of Basrah Department of Ecology. About 200 students each year are involved.	These courses work on fundamental ecology and the interaction with physical, chemical, and biological components of the ecosystem. The course provides an overview of ecology from the individual organism to populations, communities, and ecosystems, and includes

UNIVERSITY OF BASRAH SUSTAINABILITY REPORT



			a comparative treatment of terrestrial and aquatic ecosystems.
3	MSc. Ecotechnology	In College of Science University of Basrah Department of Ecology. About 25 students each years are involved.	A course in Ecotechnology blends the knowledge relating to natural science, social science and engineering with the objective to prevent and avoid environmental problems in a sustainable way.
4	MSc. Advanced Biodiversity	In College of Science University of Basrah Department of Ecology. About 25 students each year are involved.	This course focuses on the threats causing biodiversity loss and the importance of biodiversity conservation. In this course, students will apply the common diversity indices within various biomes. Students will be introduced to the theory and principals involved in conservation and learn about governmental and non-governmental efforts to protect natural environments and develop sustainable practices to meet human needs.



<p>5</p>	<p>MSc. Solid Waste Recycling</p>	<p>In College of Science University of Basrah Department of Ecology. About 10 students each year are involved.</p>	<p>This course focuses on the manage solid waste and how to reuse or recycle it using scientific methods in the environment and how to benefit from it in our daily life</p>
<p>6</p>	<p>BA. Water treatment technologies</p>	<p>In College of Science University of Basrah Department of Ecology. About 200 students each year are involved.</p>	<p>This course aims to learn about the physical, chemical, and biological treatment of water and wastewater. Wastewater treatment course that deals with systems utilizing mechanical unit operations—water background and benefits from it daily. Also, identify the devices used in purification in different environments.</p>
<p>7</p>	<p>BA. Climate Change</p>	<p>Compulsory Course In 2nd stage at College of Science University of Basrah Department of Ecology. About 200</p>	<p>This course concerns Studying the climatic reality in Iraq and the world, climatic changes and global warming as a global problem and identifying the most important elements of climate and how these</p>



		students each year are involved	elements affect the ecosystem.
8	BA. Environmental Chemistry	Compulsory Course In 2 nd stage at College of Science University of Basrah Department of Ecology. About 200 students each year are involved	The student can identify the sources of chemicals in the air, water, soil, and forms in the environments and their interactions, transformations, and effects on the living and the ultimate destiny of these materials in the environment. And cycles of some essential elements of biology and the environment.
9	BA. Wetland Ecology	The course is in stage 3 rd in College of Science, Department of Ecology. About 100 students are involved	The course topic covers the characteristics and factors affecting the existence of living organisms and environmental stress—Flora, and Fauna of wetlands and their adaptations. Resist change in environmental factors. Identify the importance of wetland functions and biodiversity. Plant and animal habitats and their niches in ecosystem.



<p>10</p>	<p>BA. Air Pollution</p>	<p>The course is in stage 3rd in College of Science, Department of Ecology. About 100 students are involved</p>	<p>The course topic covers air pollutants characteristics stationary, mobile sources of air pollutants. Increase knowledge of air pollutants measurement. Identify the health effects of indoor and outdoor of air pollutants. Learn about the methods of treating and controlling air pollutants.</p>
<p>11</p>	<p>BA. Water and Soil Pollution</p>	<p>The course is in stage 3rd in College of Science, Department of Ecology. About 100 students are involved</p>	<p>The course works on water and soil pollutants sources and mechanisms to control and reduce them. Regulations and notifications according to water quality and pollution. Importance of the aquatic environment for life on earth. Identify the primary forms of environmental pollution. Identify the effects of different environmental pollutants on various forms of life and the damage they cause to the ecosystem.</p>





<p>12</p>	<p>BA. Organic Pollution</p>	<p>The course is in stage 3rd in College of Science, Department of Ecology. About 100 students are involved</p>	<p>This course aims to increase the students' knowledge of the types of organic pollutants, their sources, environmental effects, and the physical, chemical and biological changes they cause. Identify the most important non-natural sources of organic pollutants in the air, water, soil and their transformations.</p>
<p>13</p>	<p>BA. Waste treatment and recycling</p>	<p>The course is in stage 4th in College of Science, Department of Ecology. About 100 students are involved</p>	<p>The course aims to teach the students how to manage solid waste and reuse or recycle it using scientific methods in the environment and benefit from it in our daily lives. Understand how solid and liquid waste affects the different backgrounds and how it is affected by it. Give the knowledge of the environmental role waste plays in different environments and its effects on humans and health.</p>
<p>14</p>		<p>Compulsory course in Medicine, Pharmacy,</p>	<p>The course includes the basic concepts that must be</p>



	Medical ethics course	Dentists and Nursing College in the University 2 medicine colleges and 1 pharmacy college and 1 Dentist College and 1 Nursing College) about 2800 students each year.	adopted by health workers in terms of preserving the patient's dignity, preserving his secrets, and working to relieve the psychological and physical pain he suffers without gratitude for him. The course also explains the concepts of the oath that these students take called the Hippocratic Oath of Medicine.
15	Sociology and equality course	This course in Education Colleges, which are Three Colleges in the University of Basrah TWO of them, are mixed girls and boys and one is just for girls. About 1400 students each year are involved.	Introduction to Sociology. This course introduces the student to the social structure of society and its components. The differences that result from multiculturalism and how they can life together and may make family formation, and sub-communities within the same society without discrimination.
16		These courses in Education Colleges, which are three Colleges in the	Educational psychology explains the student the



	<p>Educational Psychology course</p>	<p>University of Basrah TWO of them, are mixed girls and boys and one is just for girls. About 1400 students each year are involved.</p>	<p>psychological aspects that he may face when he graduates and be a teacher in schools and how he should deal with each case while teaching students. Poverty, hunger and bullying are some examples of these aspects.</p>
<p>17</p>	<p>Sustainability Development Subject</p>	<p>This subject in stage 3 in Economic College in the University of Basrah, the University owns two economic Colleges. About 1200 students are involved this subject each year. This subject in stage 2nd in College of Science, Department of Ecology. About 250 students are involved this subject each year.</p>	<p>The subject learns the 17th Goals of United Nation. It learns how to deal with any negative points that face the follow of these goals. The course includes an introduction to ecosystems service concepts. Importance of biodiversity and its levels in the stability of ecosystems, according to the variety of species. The course increases the knowledge of the factors affecting biodiversity and species extinction and the concept of sustainable development and its scientific principles.</p>

UNIVERSITY OF BASRAH SUSTAINABILITY REPORT



<p>18</p>	<p>Urban development Subjects</p>	<p>This subject in stage 3rd in Economic College in the University of Basrah, the University owns two economic Colleges. About 1200 students are involved this subject each year.</p>	<p>The subject deal with the benefit way of Urban area and how the</p>
<p>19</p>	<p>The economics of renewable energy</p>	<p>This subject in stage 4 in Economic College in the University of Basrah, the University owns two economic colleges. About 1000 students are involved this subject each year.</p>	<p>The course teaches the requirement of students to understand the benefit of green energy and the economics of renewable energy and the feasibility of these types of projects.</p>
<p>20</p>	<p>Ecology and Energy</p>	<p>This subject in stage 4 in Economic College in the University of Basrah, the University owns two economic colleges. About 1000 students are involved this subject each year.</p>	<p>These subjects study the environment and the way that the energy may harm it and how to deal with this crisis in our community. The effect of nonrenewable energy on Ozone layer, green house, and smoke.</p>



		<p>This subject in stage 3th in College of Science, Department of Ecology, in the University of Basrah. About 100 students are involved this subject each year.</p>	<p>This course covers energy resources and their role in modern society, with both national and global perspectives. Using sustainable energy of solar, wind, hydro and biomass energy resources will be introduced</p>
21	Census	<p>This subject in stage 4 in Economic College in the University of Basrah, the University owns two economic Colleges. About 1000 students are involved this subject each year.</p>	<p>The subject is contain two parts one is taught part and the other is research part. It is important to understand the way to do the census in our community and the way of increase or decrease the effect of the community on the resources.</p>
22	Green Chemistry	<p>The subject is in College of Science stage 3. Which involved by 880 students.</p>	<p>Green chemistry is the design of chemical products and processes that reduce or eliminate the generation of hazardous substances. EPA's efforts to speed the adoption of this revolutionary and diverse discipline have led to significant environmental</p>



			benefits, innovation and a strengthened economy.
23.	Water and life	<p>The subject is in stage 3th College of Science, Department of Ecology , which involved by 100 students</p> <p>The subject is new in College of Agriculture and Marine Sciences College in University of Basrah.</p> <p>About 2300 students are involved.</p>	<p>The course aims to study the biota that lives in fresh, brackish, and marine environments,—also, studying their interactions with environmental factors. The course clarifies the effects of the environmental factors on the organism. Its activity according to the changes of environmental factors.</p> <p>Water is essential to life</p> <p>Public drinking water safety</p> <p>Sources of drinking water in Iraq</p> <p>Private drinking water safety</p> <p>Public drinking water protection</p> <p>Working toward safe drinking water is everyone’s responsibility.</p>



<p>24.</p>	<p>BA. Environmental Disasters</p>	<p>The subject is in stage 3th College of Science, Department of Ecology , which involved by 100 students</p>	<p>This course works on disasters, their types, causes and methods to deal with them, studying the health effects of environmental disasters, managing disasters before, during and after their occurrence, identifying ways to deal with disasters, providing relief to the afflicted, and rehabilitating the community after the disaster</p>
<p>25.</p>	<p>Conserve of the living organisms</p>	<p>In College of Science University of Basrah Department of Ecology. About 50 students in 3rd stage each year are involved. The College of Agriculture and Marine Sciences College in University of Basrah.</p>	<p>The course works on the nature reserves, their types and the conditions required sustaining the wildlife, as well as how to collect and analyze data for conserving and protecting organisms.</p> <ul style="list-style-type: none"> - Protecting species from extinction - Marian Organisms - Aquatic and terrestrial organisms

UNIVERSITY OF BASRAH SUSTAINABILITY REPORT



		About 2300 students are involved.	<ul style="list-style-type: none"> - Plant and animal conserves - The marshes and their role in protecting species
26.	BA. Environmental Awareness	Compulsory Course in all departments at the College of Science in the University of Basrah in 4 th stage. About 500 students each year.	The course aims to teach the students the meaning and importance of environmental awareness and its objectives and how to raise awareness among people to conserve and protect the environment and its components. It also clarifies the most important environmental problems and phenomena of imbalance of the ecosystem and solutions to reduce them.
27.	BA. Environmental laws and legislation	The course is in stage 4 th in College of Science, Department of Ecology. About 100 students are involved	The course works on the international laws and conventions of environmental protection. Focusing on understanding how humans interact with the environment Understand the human role in preserving and sustaining the environment Knowing the



			essential summaries of the concept of laws and legislation.
28.	BA. Environmental Impact Assessment	The course is in stage 4 th in College of Science, Department of Ecology. About 100 students are involved.	The course aims to teach the student the process of evaluating the potential impacts (negative or positive) of a proposed project on the natural environment. This course aims to give decision-makers a way to decide whether to continue or stop the project. Monitoring EIA is the planned and systematic collection of environmental data to meet specific ecological goals and needs.
29.	BA. Phytotechnology	The course is in stage 4 th in College of Science, Department of Ecology. About 50 students are involved.	The course aims to teach the students the application of environmentally sound technologies especially the role of plants in reducing pollution and the effect of f microorganisms in the environment and their participation with plants for

UNIVERSITY OF BASRAH SUSTAINABILITY REPORT



			<p>treatment. This course covers fundamental process applications of phytotechnologies and natural and constructed wetlands in removing nutrients or pollutants.</p>
30.	BA. Environmental Sanitation	<p>The course is in stage 4th in College of Science, Department of Ecology. About 50 students are involved</p>	<p>This course aims to increase the knowledge of the student to the methods used in restoring natural systems to their normal state after significant impacts on them that led to their deterioration.</p>
31.	BA, Waste Recycling	<p>Marine Sciences College</p>	<p>Develop a complete vision for the student about the environmental pollution, waste and the importance of recycling</p>
32.	BA, Health Culture	<p>Marine Sciences College</p>	<p>The course seeks to develop physical and mental capabilities of individuals to the fullest extent and allow them to live a socially, economically and culturally productive life in harmony</p>





			with their environment, ideas, and their desires.
33.	BA, Wetland Environment,	Marine Sciences College	By the end of this course, the student will have a complete perception for about the importance of wetlands in the world and in Iraq in particular.
34.	BA, Fish taxonomy,	Marine Sciences College	The science of fish taxonomy focuses on the foundations and systems that follow to study the division of fish, and there are ways to classify fish that differ from each other
35.	BA, Water Ecology	Marine Sciences College	water ecology, like other sciences, presents the general description and the presence of living organisms and their types and their relationship among them in their locations, as well as mentioning the physical and chemical factors for that region.
36.	BA, Marine Invertebrates	Marine Sciences College	This course includes all animals apart from the vertebrate members of the chordate phylum, focusing on



			of the biology, ecology and behaviour of such invertebrates.
37.	BA, Environmental pollution,	Marine Sciences College	This subject investigates the levels and behaviour different contaminants such as heavy metals, pesticides, oil and industrial products. In addition, lab-work research attempts to address problems that related to local or global environment.
38.	BA, Marine Ecology,	Marine Sciences College	Most of the Arab countries have wide marine coasts, and many of them depend on the marine environment and its resources.
39.	BA, Microbiology,	Marine Sciences College	The microbiology course includes the groups of organisms that fall under this title, starting with bacteria and their composition, passing through eukaryotic microorganisms such as fungi and protozoa. Study ways of



			feeding them, and their role in the ecosystem.
40.	BA, Ecotoxicology	Marine Sciences College	The Ecotoxicology course includes toxins and their branches, the types of toxins in the environment and their effects on the ecosystem generally and human health particularly.
41.	BA, Marine Chemistry,	Marine Sciences College	This subject focuses on composition and structure of the substances in the marine environment and the processes that courses in this environment
42.	BA, Environmental Chemistry	Marine Sciences College	This subject involves the study of the influence and reactions of chemicals that have on the air, water and soil, and their human health effects.
43.	BA, Strucutral Geology	Marine Sciences College	This course describes, in a general basic framework, the plates tectonic and their relations among different oceanic and continental



			crusts, and their characteristics
44.	BA, Coastal Water Chemistry	Marine Sciences College	A presentation of the most important characteristics of the marine coastal area and a description of the most important interactions taking and how the natural cycles of the major elements are completed in that area.
45.	BA, Sedimentology	Marine Sciences College	It is interested in studying the sedimentary layers of the earth and the mineral wealth they contain, as well as the most important sedimentary structures and deposition processes.
46.	BA, Meteorology	Marine Sciences College	Studying weather and climate patterns, physical and chemical properties of the atmospheric gases, as well as studying climatic phenomena, how occur, and the measuring devices.
47.	BA, Marine Currents	Marine Sciences College	The course is concerned with studying the types of ocean

UNIVERSITY OF BASRAH SUSTAINABILITY REPORT



			currents, their characteristics and the factors affecting it, in addition to the methods of measuring.
48.	BA, Downstream physics	Marine Sciences College	Study of the movement of currents and the influence of the atmosphere on the Downstream, in addition to the ocean's heat budget.
49.	BA, Oceanography	Marine Sciences College	Study oceans and seas in terms of physical, geological, chemical and biological aspects and the most important phenomena in them and their emergence.
50.	Transport infrastructure, railways, and motorways.	Topics taught in the Department of Geography, College of Education for Human Sciences, in undergraduate studies	Transport infrastructure is an important axis of the preliminary study in the field of geography to build a future development culture and achieve the drawn strategic plan, and railway structures represent an evolutionary axis that is highlighted to treat congestion problems and economic effects as well as protect the environment, as



			<p>well as study the infrastructure of cars and transportation methods How is it built and what are its goals?.</p>
51.	<p>International shipping routes in major oceans and seas</p>	<p>Topics taught in the Department of Geography, College of Education for Human Sciences, in undergraduate studies</p>	<p>oceans and seas</p> <p>Studying international navigation routes in the oceans and seas, and developing concepts with their economic and industrial axes, including diversification and sustainability in the ways and means.</p>
52.	<p>Ports and harbors, their types and importance</p> <p>Maritime and river transport</p> <p>The importance of its infrastructure and the factor influencing it</p>	<p>Topics taught in the Department of Geography, College of Education for Human Sciences, in undergraduate studies</p>	<p>Ports, harbors and international shipping channels</p> <p>It is an infrastructure in which the focus is on the issue of sustainability and what is achieved from it on the economic and all other levels. It is the basis of economic, social and intellectual communication.</p> <p>sea and river transport</p>



	<p>global merchant fleet</p> <p>Kind and importance</p>		<p>It is one of the topics that belong to the central development goals, including the resources it achieves, and the developmental impact it leaves on more than one side.</p> <p>The global merchant fleet, its importance and types</p> <p>This is complemented by other means that have an effective impact on achieving development and global communication on all aspects</p>
<p>53.</p>	<p>Fighting poverty and hunger</p>	<p>Specialized studies to fight poverty and hunger, postgraduate and preliminary studies at the College of Education for Human Sciences</p>	<p>1- Spatial analysis of the phenomenon of poverty in the city of Basra using geographic information systems (PhD thesis)</p> <p>2- Geographical Distribution of the Unemployed Population in the Shatt Al-Arab District for the Years 1997 and 2017, Sa magazine and the Qur'an Dhikr, Issue 22, Winter 2019, p. 545</p> <p>3- Poverty indicators and trends in its rates in Iraq from</p>

UNIVERSITY OF BASRAH SUSTAINABILITY REPORT



			<p>2007-2017. Midad Al-Adab Magazine, Iraqi University, Baghdad, a special issue of the 2018-2019 conferences</p> <p>-4Child labor in the city of Khor Al-Zubayr in 2016, the magazine of S and the Qur'an that is mentioned, volume 22, winter 2019 p. 37-</p>
54.	The impact of climate change on sustainable development	<p>Documented scientific studies and study topics in primary and postgraduate studies. College of Education for the Humanities</p>	<p>The impact of climate changes on sustainable development is based on the study of the climate and its immediate and future changes and how these changes are used to achieve economic and health sustainability by employing these changes to serve these aspects and ward off their danger</p>
55.	Primary Education Service Evaluation	<p>Objective study on education in the regions of Basra. College of Education for Human Sciences</p>	<p>The study is based on diagnosing the problems that education suffers from, and then finding solutions to solve these problems with the scientific tools used by researchers.</p>



<p>56.</p>	<p>Human rights, justice and empowerment</p>	<p>Study vocabulary in the primary study at the College of Education for Human Sciences</p>	<p>Non-governmental organizations and human rights - International Committee of the Red Cross - Amnesty International - Human Rights Watch Organization, National Human Rights Organizations - Human rights in Iraqi constitutions between theory and reality, modern human rights Facts in development: the right to a clean environment - the right to solidarity - the right In religion, guarantees of respect and protection of human rights at the national level - guarantees in the constitution and laws - guarantees in the principle of the rule of law.</p>
<p>57.</p>	<p>economical development</p>	<p>Elementary and Postgraduate Vocabulary Topics College of Education for Human Sciences</p>	<p>A study on the agricultural reality and its reform to achieve economic development according to the lifting of obstacles to development and sustainability based on strategic plans</p>



<p>58.</p>	<p>Behavior Modification Phase 4</p> <p>Learning and its relationship to behavior modification.</p> <p>The nature of learning.</p> <p>Learning concept.</p> <p>The importance of learning in behavior.</p> <p>Learning theories and their applications in behavior modification.</p>	<p>Vocabulary and topics taught in the last year of the Department of Educational Guidance in the College of Education for Human Sciences</p>	<p>Determining the frameworks through which education plays its pivotal role by studying behavior modification in the early university stages and learning and its relationship to behavior modification and the nature of this learning as well as the concept of learning.</p> <p>The importance of learning in behavior and learning theories and their applications in behavior modification.</p>
------------	--	---	---





59.	Mental health at school	Methodological topics taught to students in the College of Education for Human Sciences	These topics are concerned with the development of mental health in the school, which is the health of students and what qualifies them to be able in the future to lead after the growth of their mental health to ensure success.
60.	Political Systems	College of law /second stage	This item focuses in one of their topics on the peaceful exchange of power according Iraqi and other political systems
61.	Public international law	College of law / third stage	Public international law, which studies international relations and the resolution of disputes between states by peaceful means
62.	Environmental economics	College of demonstrations and economics\ stage 3 economics oil	This subject teaching about the Environmental and Environmental opinions and how we keep them for subsequent valves
63.	Sustainable energy	College of demonstrations and	This subject teaching about it deals with everything related to renewable energies and

UNIVERSITY OF BASRAH SUSTAINABILITY REPORT



		economics\ stage 4 economics oil	how to get rid of the effects left by fossil fuels
64.	Water Quality	College of Agriculture	This course work on based on the adopted Water Quality Standards, establish designated uses for surface and ground waters and identify the criteria necessary to support those uses.
65.	Marine Environment	College of Agriculture	The marine environment encompasses a vast array of unique ecosystems, extending from coastal regions to deep oceans and includes some of the most threatened habitats, particularly the world's coral reefs.
66.	Biology of Polluted Water	College of Agriculture	The main water pollutants include bacteria, viruses, parasites, fertilisers, pesticides, pharmaceutical products, nitrates, phosphates, plastics, faecal waste and even radioactive substances. These substances do not always change the colour of the water, meaning



			<p>that they are often invisible pollutants. That's why small amounts of water and aquatic organisms are tested to determine water quality.</p>
<p>67.</p>	<p>Ecological Poisoning</p>	<p>College of Agriculture</p>	<p>There is increasing public interest and concern over matters of human health and environmental quality. We commonly hear news reports of health problems that may be associated with some chemical(s), but few people have sufficient background to understand the problems in detail. Toxicology, the study of adverse effects of chemical contaminants on living systems, forms the basis of our ability to predict and prevent adverse effects to human health and the environment .Without an understanding of the basic principles of toxicology, one cannot make a fully informed decision about the true risks and benefits of anthropogenic</p>



			<p>and natural chemicals to humans and other organisms. This course will provide a broad overview of toxicology and allow students to recognize the relevance of the science in their lives and surroundings</p>
68.	Advanced Environmental Pollution	College of Agriculture	<p>Our course provides you with a strong grounding in the quantitative and qualitative skills required to address environmental questions in addition to subject-specific knowledge and understanding.</p>
69.	Aquatic Management	College of Agriculture	<p>The participants gain the skills, knowledge, and applied practical experience in risk management, legislation, and operating practices that dictate the current operating standards of aquatic facilities in Alberta and Northwest Territories.</p>



70.	Biological Oceanography	College of Agriculture	<p>The course introduces the students to biological oceanography. Subjects covered include: Marine life in the oceans, biochemical adaptations to environmental variables, life-history traits, reproduction, hydrography, ocean geography, water masses, seawater characteristics.</p>
71.	Fish Health Management	College of Agriculture	<p>Successful fish health management begins with prevention of disease rather than treatment. Prevention of fish disease is accomplished through good water quality management, nutrition and sanitation. Without this foundation it is impossible to prevent outbreaks of opportunistic diseases.</p>
72.	Limnology	College of Agriculture	<p>Introduction to limnology: kinds of inland water, their features, and distribution; ponds and lakes; streams and</p>





			rivers; lentic and lotic ecosystem dynamics.
73.	Marsh and Wetland Environment	College of Agriculture	Professionals working in Marsh and wetland management and/or wastewater treatment will benefit from this training. They might be employed by organisations that deal with water treatment or with wetlands conservation and sustainable usage.
74.	Marine and Estuarine Environment	College of Agriculture	Students in the programme have a wide range of interests, but they always revolve on some element of the interaction between biological, physical, and chemical systems in the environment
75.	Aquatic Ecology	College of Agriculture	This brief course focuses on the fundamentals of understanding how the environment and aquatic system interact. It covers topics such as ecological processes, species



			distribution, community structure, function, and change.
76.	Environmental Pollution	College of Agriculture	The primary issues of pollution of the atmosphere, water, land surface, and food chain are discussed in this course. It includes the processes that cause pollution to arise and be released into the environment, as well as dispersion mechanisms, the dangers associated with various types of pollutants, toxic substanc.
77.	Biotechnology	College of Agriculture	The main enabling technologies that support biotechnology research, such as enzyme discovery and engineering, systems and synthetic biology, and biochemical and process engineering, will be covered in this course.
78.	Dairy Processing	College of Agriculture	This course is intended to supplement a learner's current understanding of general food



			<p>science or to offer a starting point for individuals interested in learning more about dairy foods. The foundations of milk and milk processing, including chemical and physical characteristics, diverse dairy products, safety, and sustainability, are covered in this course.</p>
79.	Functional Food	College of Agriculture	<p>Foods that offer a health benefit beyond nutrition are known as functional foods. Functional foods are a hot topic in public health since many bioactive components offer a lot of promise in terms of chronic disease prevention.</p>
80.	Enzymes	College of Agriculture	<p>Enzymes are involved in all major cellular processes. They use food to release energy and store it in other sorts of molecules, as well as produce proteins that supply cell structures.</p>
81.	Biofilm	College of Agriculture	<p>The course's goal is to provide attendees a basic grasp of</p>



			biofilm and where to look for it.
82.	Antioxidants	College of Agriculture	Antioxidants play a critical role in the human body's overall health. They are essential in preventing or decreasing the oxidation of other biomolecules.
83.	Dairy Technology	College of Agriculture	This course concerns studying a science and engineering field that deals with the study of milk processing and its products.
84.	Industrial Microbiology	College of Agriculture	Microorganisms' physiology, feeding, and growth are vital to a variety of businesses. In the industrial manufacturing process, microbial proliferation must be controlled. Microorganisms are used in the creation of cells, primary and secondary metabolites.
85.	Dairy fermentation	College of Agriculture	This is a basic introduction to dairy fermentation. These ferments are not only



			<p>delicious, but they are also high in probiotics, which will help your gut microbiota thrive. Yogurt (includes how to make Greek yoghurt), Buttermilk, Creme Fraiche, Buttermilk Ranch Dressing, and kefir sourdough bread</p>
86.	Feed and diet	College of Agriculture	<p>Learners will receive the information and practical skills they need to begin improving their eating habits in this course. This course will change the focus away from nutritional reductionist arguments and toward practical conversations about actual food and the context in which we consume it.</p>
87.	Animal production mechanization	College of Agriculture	<p>Students will gain a complete introduction of animal anagement, nutrition and feed, health, and breeding during this study time. Students will be prepared to work in an animal production</p>



			environment after completing this level.
88.	Animal feeding	College of Agriculture	This course will teach you how to utilise control systems and testing procedures to improve the quality of animal feed. You'll learn about several forms of animal feed production, as well as challenges that impact feed quality and regulatory requirements.
89.	Feed manufacturing	College of Agriculture	The course is intended for animal feed mill managers who want to further their education and training.
90.	Medicinal and aromatic plants	College of Agriculture	This is an introduction course to medicinal and aromatic plant production, processing, and commercialization on the Prairies.
91.	Handling and storage of horticultural crops	College of Agriculture	The course integrates basic biological knowledge with industry practices and introduces current research topics. The course is focused



			on examining the key concepts of postharvest biology that can be applied to multiple crops rather than exhaustively detailing handling and storage criteria for specific crops.
92.	Organic farming	College of Agriculture	Organic farming is an integrated agricultural production method based on ecological principles, biodiversity promotion, biological cycles, and organic matter recycling in order to preserve and increase soil fertility and environmental sustainability.
93.	Production of vegetable seeds	College of Agriculture	Many subsistence farmers in underdeveloped nations rely on reliable seed supply to sustain vegetable output and availability, as well as to ensure food security.
94.	Date palm Production	College of Agriculture	This course targeted the date palm trees specialists. The course tackled the following: the economic importance and nutritional value of dates, how



			to create a date palm plantation
95.	Tissue culture	College of Agriculture	Tissue culture is the process of growing plants in a laboratory from extremely small (often microscopic) pieces. It is a technique of dissemination that is becoming more popular.
96.	Fruit production	College of Agriculture	The management technologies and cultural practices of fruit crops including (but not limited to) blueberries, blackberries, raspberries, strawberries, grapes, peaches, and apples will be presented.
97.	Vegetable production	College of Agriculture	Vegetables have the benefit of providing a rapid return on investment. Planting and harvesting most veggies takes only 6 weeks to 6 months. Vegetables, on the other hand, can be risky. Prices might fluctuate dramatically from day to day.



98.	landscape design	College of Agriculture	Our landscape design programmes equip students for employment as creative landscape designers.
99.	Fertilizers technologies	College of Agriculture	This is an introduction course that covers the full spectrum of items that increase soil fertility in a clear and straightforward manner.
100.	Soil conservation	College of Agriculture	<p>The Soil Conservation Service team is available to share their practical skills and experience in our comprehensive training program.</p> <p>These training programs help project managers, civil engineers, plant operators, rural landholders and environmental managers implement best practice techniques in environmental management and natural resource conservation.</p>
101.	Soil reclamation	College of Agriculture	The Land Reclamation certificate includes courses focused on soil and vegetative princi-



			<p>ples, land use guidelines and related regulations, soil classification, testing, and evaluation, as well as restoration and rehabilitation methods.</p>
102.	Desertification	College of Agriculture	<p>The training course covers technical issues such as causes of desertification/land degradation, seed and seedling production, forestation, erosion control and participatory approach with the aim of increasing the level of regional collaboration.</p>
103.	Principles of field crops production	College of Agriculture	<p>This is an introductory course in agronomy with a goal to provide the general principles underlying crop production. The course examines the dynamics and functions of crop communities, influence of the environment on crop production, plant morphology and metabolism, crop growth and development, plant breeding as well as soil water management.</p>



<p>104.</p>	<p>Production of Oil and sugar crops</p>	<p>College of Agriculture</p>	<p>Grains production is one of the world's greatest agricultural businesses, providing staple foods like wheat, rice, and corn that are necessary for the survival of the majority of the world's people. This is a dynamic industry that is becoming increasingly technical.</p>
<p>105.</p>	<p>Production of Fiber crops</p>	<p>College of Agriculture</p>	<p>Most insects are not pests, and many beneficial insects are commonly found in crops, helping to manage a variety of pests while also providing other ecosystem services such as pollination and nutrient cycling.</p>
<p>106.</p>	<p>Technology of Cereal</p>	<p>College of Agriculture</p>	<p>This course is aimed to provide students in the Food Science and Technology department a better understanding of how cereals are processed and used. It involves grain milling, particle size analysis, product and by-product use, and more.</p>



<p>107.</p>	<p>Weeds and their control</p>	<p>College of Agriculture</p>	<p>The categorization, life cycles, features, and management of weeds are covered in this course, with an emphasis on common and noxious weeds in Iraq.</p>
<p>108.</p>	<p>Soil preparation equipment</p>	<p>College of Agriculture</p>	<p>The science and policy behind the best management methods will be covered in this course, as well as the agricultural and urban water quality concerns in Florida, their causes, land and nutrient management techniques, and the science and policy behind the best management practises.</p>
<p>109.</p>	<p>Maintenance of tractors and agricultural equipment</p>	<p>College of Agriculture</p>	<p>This course is designed for people who want to pursue a career in agriculture. This certificate will help you reach where you need to go, whether you were raised on a farm and want to improve your expertise or you are entirely new to farming.</p>



<p>110.</p>	<p>land reclamation equipment</p>	<p>College of Agriculture</p>	<p>The use of a wide understanding of environmental elements such as ecology, forestry, soils, agriculture, botany, native, water, pollution, and invasive plant species is known as land reclamation. Disturbed sites frequently have unfavourable features that must be addressed.</p>
<p>111.</p>	<p>agricultural economy</p>	<p>College of Agriculture</p>	<p>In agriculture, economic thinking is critical since a farmer's livelihood is dependent on the consequences of their actions. Economic data is also required by governments when making policy decisions on behalf of communities.</p>
<p>112.</p>	<p>Principles of plant protection</p>	<p>College of Agriculture</p>	<p>Plant protection concepts will be studied for pest control of field, pasture, and horticultural crops.</p>



<p>113.</p>	<p>Irrigation and drainage systems</p>	<p>College of Agriculture</p>	<p>Agricultural engineering has been used to optimise the use of natural resources in agricultural production for the benefit of humanity. This course focuses on the use of irrigation and drainage concepts in agriculture to achieve profitable crop production while minimizing environmental impact.</p>
<p>114.</p>	<p>Integrated Pest Management and Biological Control</p>	<p>College of Agriculture</p>	<p>By the completion of the course, the student has a thorough understanding of the concepts of integrated and biological pest control, as well as a thorough understanding of sustainable plant protection.</p>
<p>115.</p>	<p>Biological Control</p>	<p>College of Agriculture</p>	<p>The course teaches students to the basic ideas of insect biology, such as the use of illnesses, predators, parasites, and parasitoids to manage pests, and so on. There are also two field trips included.</p>



<p>116.</p>	<p>Pharmacoeconomy</p>	<p>College of pharmacy Department of Clinical pharmacy for 5th stage students</p>	<p>This subject teaching about basic understanding of the tools needed to assess the costs and outcomes of medications and pharmaceutical care services. It will enable participants to evaluate the pharmacoeconomic and quality of life literature for the purpose of rational decision-making. Students will be exposed to the drug-focused approaches to pharmacoeconomic research and the fundamentals of quality of life research.</p>
<p>117.</p>	<p>Pharmacognosy</p>	<p>College of pharmacy, department of pharmacognosy 2nd &3rd stage students</p>	<p>This course is intended to study the scope of pharmacognosy, Medicinal plant nomenclature, classification of natural products, photochemistry which include extraction and isolation of active constituents from natural sources which may be used as product in</p>



			future for treatment certain medical conditions
118.	Organic Pharmaceutical Chemistry III	College of pharmacy, Department of pharmaceutical chemistry for 4th stage students:	To enable understanding mechanisms of drug action, including antibacterial, antifungal and antiviral agents, at molecular level, and the role of medicinal chemistry in the discovery and development of synthetic therapeutic agents . like design and synthesis of new chemotherapeutic agents and hormone derivatives with potential biological activity
119.	General toxicology	College of pharmacy Department of pharmacology and toxicology for 4th & 5th stage students	To study the principle of exposure to different chemicals and environmental factors, their sources, mechanisms of toxicity and their risk to human being; it used to understand the required measures to protect living organisms against the suspected toxic hazards. And provide knowledge to how to deal with the toxicity of chemicals and drugs in clinical



			settings; it enables students to correlate signs and symptoms of toxicity with the analytical data, and to know how to establish preventive and therapeutic measures for poisoning cases.
120.	Public Health	College of pharmacy Department of Clinical pharmacy for 4th stage students	This course enables the students to understand the principles of public health and the art of preventing disease, promoting health and prolonging life, through organized effort of society.
121.	Wireless Sensor Networks (WSNs)	College of IT and Information Technology	This Course deals with the Wireless sensor network for monitoring many phenomena related to the sustainability such as building a WSNs for monitoring the plant and agricultural phenomena. It also deals with design an actuators-based WSN that is used in smart buildings.





<p>121</p>	<p>Introduction to Renewable Energy</p>	<p>College of Engineering</p>	<p>This course deals with Today's energy use, Fossil fuels and environmental impact, Renewable energy source and devices. It also discussed Availability of wind energy, Wind turbines, wind parks and power control.</p>
<p>122</p>	<p>Smart Grid</p>	<p>College of Engineering</p>	<p>This course deals with the Smart Grid Technologies along with Smart Meters, Advance Metering Infrastructure and power Quality Management in Smart Grid.</p>
<p>123</p>	<p>Principles of Robotics</p>	<p>College of Engineering</p>	<p>This course give an introductions to the robotics systems that is being used in automations of building.</p>
<p>124</p>	<p>Industrial Automation</p>	<p>College of Engineering</p>	<p>This course provide hours of programming the automation of industrial by using different programming languages that deals with sensors and actuators.</p>



125	Soft Computing Techniques	College of Engineering	This course discusses the computational intelligence systems and how to programming them using fuzzy logic, bio-inspired algorithms, and machine learning technique.
126	Engineering Economics	College of Engineering	This course dealing with how to Making Economic Decision regarding many engineering subjects, one of those subject is the Renewable Energy Projects from economic perspective.
127	Introduction to Nanotechnology	College of Engineering	This course provide a background and definition of Nanotechnology. Hence, one of the most topic in this course is dealing with Medical Applications of Nanomaterial: drug delivery, Cancer, Surgery, Nano robots, and Cell repair.
128	Advance in Renewable Energy	College of Engineering	This course significantly dive into the latest technique of renewable energy. It provides hours of workshop on how to build a renewable energy



			devices whether it was a wind-based mechanism or radiation-based mechanism.
129	sanitary sewage engineering	College of Engineering	This course provide and discuss the latest method and strategies to enhance human community sanitation, notably by ensuring the handling and disposal of human waste, as well as the provision of safe drinkable water.
130	Buildings sustainability	College of Engineering	This course provide the latest strategies for sustaining and maintaining the buildings from material perspective (i.e. how to maintain the materials of buildings)
131	soil mechanics	College of Engineering	This course discuss the problems of soil failures and how to handle those problems.
132	Water Technologies	College of Engineering	This course discuss the latest technologies that provides top-quality water. This course also explain how to provides potential for local and

UNIVERSITY OF BASRAH SUSTAINABILITY REPORT



			integrated water supply solutions, as well as technology for the use and reuse of freshwater.
--	--	--	---

Currently, all the vocabulary of Iraqi university curricula is being updated and it is hoped that sustainability topics will be included in all courses offered by the university.

The total number of courses involving sustainability at the university is 132

Total number of total courses at the university is 240

Number of courses related to sustainability in 2018	45
Number of courses related to sustainability in 2019	50
Number of courses related to sustainability in 2020	132
Average number of sustainability-related courses for three years	75

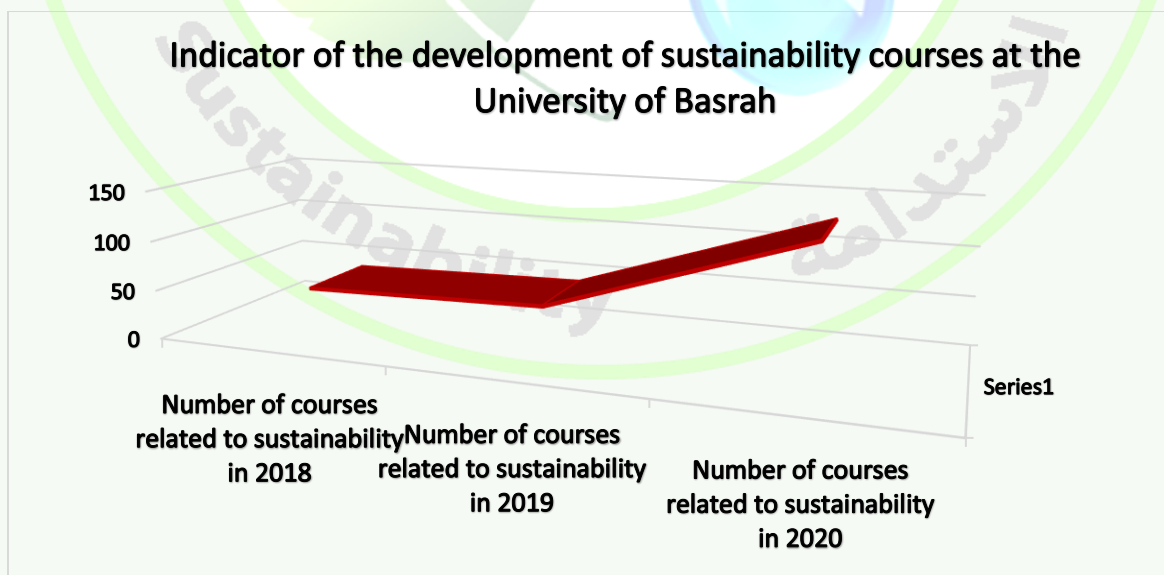



6. 1. 2. Sustainability research at University of Basrah in 2019 / 2020

The table below represents a list of research published in 2019/2020 that includes sustainability in its vocabulary, with a link to each search.

	College	Paper	link
1	College of Administration and Economics	The economic effects for CIF and FOB contracts on Iraqi foreign trading	https://search.mandumah.com/MyResearch/Home?rurl=%2FRecord%2F1031648
2	College of Administration and Economics	The effect of empowerment on the professional integration between the accountant and the auditor	https://www.asjp.cerist.dz/en/article/33395
3	College of Administration and Economics	Organizational fit and its impact on service-oriented citizenship behaviors : organizational identity as a moderator	https://search.emarefa.net/ar/detail/BIM-1103807-%D8%A7%D9%84%D8%A7%D9%86%D8%B3%D8%AC%D8%A7%D9%85-%D8%A7%D9%84%D8%AA%D9%86%D8%B8%D9%8A%D9%85%D9%8A-%D9%88-%D8%A3%D8%AB%D8%B1%D9%87-%D9%81%D9%8A-%D8%B3%D9%84%D9%88%D9%83-%D8%A7%D9%84%D9%85%D9%88%D8%A7%D8%B7%D9%86%D8%A9-%D8%A7%D9%84%D8%AA%D9%86%D8%B8%D9%8A%D9%85%D9%8A%D8%A9-%D8%A7%D9%84%D9%85%D9%88%D8%AC%D9%87%D8%A9

UNIVERSITY OF BASRAH SUSTAINABILITY REPORT



4	College of Administration and Economics	Information technology and its role in improving job performance through simplifying daily work procedures	https://iasj.net/iasj/download/e7f249eb68b68bff
5	College of Arts	Medical geo analysis of epidemical curve for emerged Corona epidemic and the suggested strategies to limit its spread	http://misan-ias.com/index.php/ojs/article/view/137
6	College of Arts	The social and economic repercussions of the COVID-19 pandemic on the family in Basra city	https://scholar.google.com/citations?view_op=view_citation&hl=ar&user=TmPy75IAAAJ&citation_for_view=TmPy75IAAAJ:W7OEmFMy1HYC
7	College of Arts	Development potential and its investment in sustainable tourism development in Al-Muthanna Governorate	https://www.iasj.net/iasj/article/181247
8	College of Arts	The water balance of the soil in Basra Governorate and its effect on the growing plants	https://www.iasj.net/iasj/download/4e302d54f5afc5ab
9	College of Arts	Historical development of municipal solid waste service in Basrah for the period between of 2003-2018	https://search.emarefa.net/ar/detail/BIM-977749
10	College of Arts	Dhi Qar Oil fields developing strategy and its future prospects	https://www.iasj.net/iasj/article/181468

UNIVERSITY OF BASRAH SUSTAINABILITY REPORT



11	College of Arts	Light pollution local analysis in the recreational sites in Najaf city	https://www.iasj.net/iasj/download/3e8b40ad9db75a2f
12	College of Arts	Factor analysis of pollution with nutrient salts in the Shatt al-Arab River in the city of Basra and its relation to some environmental variables	https://faculty.uobasrah.edu.iq/faculty/en/1500/publication5
13	College of Arts	Local analysis for the noise pollution and its effect on the school environment for Zubair city	https://www.iasj.net/iasj/article/181467
14	College of Arts	Qualitative assessment of water erosion by adopting the PAP-CAR model of the Sherwat Valley Sulaymaniyah Basin Using Rs-Gis	https://search.emarefa.net/ar/detail/BIM-977636-%D8%A7%D9%84%D8%AA%D9%82%D9%8A%D9%8A%D9%85-%D8%A7%D9%84%D9%86%D9%88%D8%B9%D9%8A-%D9%84%D9%84%D8%AA%D8%B9%D8%B1%D9%8A%D8%A9-%D8%A7%D9%84%D9%85%D8%A7%D8%A6%D9%8A%D8%A9-%D8%A8%D8%A7%D8%B9%D8%AA%D9%85%D8%A7%D8%AF-%D9%86%D9%85%D9%88%D8%B0%D8%AC-pap-car-%D9%84%D8%AD%D9%88%D8%B6-%D9%88%D8%A7
15	College of Arts	Modeling a land cover map for environmental vulnerability indicators in Nineva Governorate using RS-GIS	https://www.researchgate.net/publication/348078318_nmdhjt_khrytt_alghta_alardy_wfq

UNIVERSITY OF BASRAH SUSTAINABILITY REPORT



16	College of Arts	Associated Natural Gas in the Oil Fields in Basra Governorate: Between Reality and the Challenges in Investments and Developments	https://faculty.uobasrah.edu.iq/uploads/publications/1598201564.pdf
17	College of Arts	The geographical distribution of the population in the province of Basra and its influence in Iraq's political strength	https://search.emarefa.net/ar/detail/BIM-839544
18	College of Arts	The Spatial Variation of the Demographic Well-Being Indicators According to Statistics of 2016 in Basra Governorate (Iraq)	http://www.scielopcion.com/89/1525-1540_6_89.pdf
19	College of Arts	The economical and social consequences corona pandemic on the family in the city of Basrah	https://journals.ekb.eg/article_197676.html
20	College of Arts	Evaluating the Efficiency of Health Services in Al-Faw District	http://search.mandumah.com/Record/1142576
21	College of Arts	Local contrasting for poultry breeding and production projects in Babylon Governorate	https://www.iasj.net/iasj/article/181251
22	College of Arts	The effect of the temperature for poultry breeding and production projects in Waset Governorate	https://www.researchgate.net/publication/348078318
23	College of Arts	The affecting climate characteristics on the reality of desertification in Iraq	http://eduj.uowasit.edu.iq/index.php/eduj/article/view/241

UNIVERSITY OF BASRAH SUSTAINABILITY REPORT



24	College of Arts	Evaluating the functional efficiency of community services in Shatt Al-Arab city	https://search.emarefa.net/ar/detail/BIM-973655
25	College of Arts	The random housing and its effects on the urban structure in Nasiriya city	https://www.iasj.net/iasj/download/76045e475a13b7de
26	College of Arts	Spatial analysis of groundwater flowing artesian condition using machine learning techniques	https://www.sciencedirect.com/science/article/abs/pii/S2352801X20301223
27	College of Arts	Reading for Translation: The Cognitive Comprehension Strategies Employed in the Translation Process	https://www.researchgate.net/profile/Falih-Al-Emara/publication/342877809
28	College of Arts	An Analytical Study of the Responses of Students of Translation to Some Problems of Translation	http://misan-ias.com/index.php/ojs/article/view/197
29	College of Arts	Integrating an Intrinsic Strategy in Higher Education: Learner- Centered Approach in Language Teaching	http://www.jtuh.tu.edu.iq/index.php/hum/article/view/939
30	College of Arts	The Metaphorical Modeling of COVID-19 Pandemic Crisis in Info sphere Online News Articles	http://eduj.uowasit.edu.iq/index.php/eduj/article/view/1570

UNIVERSITY OF BASRAH SUSTAINABILITY REPORT



31	College of Education for Women	The water crisis in Basra province its causes and effects and ways to address it	https://www.researchgate.net/publication/348237427_alazmt_almayyt_fy_mhafz_t_albsrt-asbabha_watharha_wsbl_maljtha
32	College of Education for Women	The impact of climate change in the change in the specific properties of the water in the western side of Basra province in southern Iraq	https://scholar.google.com/citations?view_op=list_works&hl=ar&hl=ar&user=EjWf6GsAAAAJ
33	College of Education for Human Science	The role of sustainability in the face of crises in Iraq (Corona pandemic model)	https://www.eduj.uowasit.edu.iq/index.php/eduj/article/view/1756
34	College of Education for Human Science	Design of a proposed program and its impact on the development of conciliatory thinking among biology teachers	https://www.iasj.net/iasj/article/168228
35	College of Education for Human Science	Impact of climate change on sustainable development of water resources in Basra province	https://search.emarefa.net/ar/detail/BIM-974051-%D8%A3%D8%AB%D8%B1-%D8%A7%D9%84%D8%AA%D8%BA%D9%8A%D8%B1%D8%A7%D8%AA-%D8%A7%D9%84%D9%85%D9%86%D8%A7%D8%AE%D9%8A%D8%A9-%D9%81%D9%8A-%D8%A7%D9%84%D8%AA%D9%86%D9%85%D9%8A%D8%A9-%D8%A7%D9%84%D9%85%D8%B3%D8%AA%D8%AF

UNIVERSITY OF BASRAH SUSTAINABILITY REPORT



			<p>%D8%A7%D9%85%D8%A9-%D9%84%D9%84%D9%85%D9%88%D8%A7%D8%B1%D8%AF-%D8%A7%D9%84%D9%85%D8%A6%D9%8A%D8%A9-%D8%AF</p>
36	College of Education for Human Science	Spatial analysis of protected agriculture and its impact on sustainable agricultural development in Basra province as an application model	<p>https://search.emarefa.net/ar/detail/BIM-977708-%D8%A7%D9%84%D8%AA%D8%AD%D9%84%D9%8A%D9%84-%D8%A7%D9%84%D9%85%D9%83%D8%A7%D9%86%D9%8A-%D9%84%D9%84%D8%B2%D8%B1%D8%A7%D8%B9%D8%A9-%D8%A7%D9%84%D9%85%D8%AD%D9%85%D9%8A%D8%A9-%D9%88-%D8%A3%D8%AB%D8%B1%D9%87%D8%A7-%D9%81%D9%8A-%D8%A7%D9%84%D8%AA%D9%86%D9%85%D9%8A%D8%A9-%D8%A7%D9%84%D8%B2%D8%B1%D8%A7%D8%B9%D9%8A%D8%A9-</p>
37	College of Education for Human Science	SMART CITY SECURITY: FACE-BASED IMAGE RETRIEVAL	<p>http://e-journal.uum.edu.my/index.php/jict/article/view/6303</p>

UNIVERSITY OF BASRAH SUSTAINABILITY REPORT



		MODEL USING GRAY LEVEL COOCCURRENCE MATRIX	
38	College of Education for Pure Science	Measurement of uranium concentrations in soil samples of Al-Diwaniyah governorate, Iraq by using CR-39 track detector	http://journals.uokufa.edu.iq/index.php/jkp/article/view/9071
39	College of Education for Pure Science	Evaluation of boron concentration in water samples of Al-Diwaniya Governorate (in Iraq) using ICP/OES Techniques	http://journals.uokufa.edu.iq/index.php/jkp/article/view/8534
40	College of Education for Pure Science	Lab – Built semi- automated Stop – flow System for Spectrophotometric Determination of Nitrite in Different water Samples	https://iopscience.iop.org/article/10.1088/1742-6596/1294/7/072010/meta
41	College of Nursing	Isolating Some Pathogenic Bacteria from Packed Milk and Detecting of Formalin in its Components	http://www.ijop.net/index.php/mlu/article/view/412
42	College of Nursing	Microbial Contamination of Hospital Nebulization and Link to of Nurses 's staff knowledge in emergency Department	https://nur.uobasrah.edu.iq/images/pdfcv/sundusar.pdf
43	College of Agriculture	INFLUENCE OF FUEL DIESEL TYPE, FORWARD SPEED AND TILLAGE DEPTH ON THE TRACTOR FUEL CONSUMPTION AND THE ENERGY UTILIZATION FOR DRAFT	https://www.researchgate.net/publication/337827968 INFLUENCE OF FUEL DIESEL TYPE FORWARD SPEED AND TILLAGE DEPTH ON THE TRACTOR FUEL CONSUMPTION AND THE ENERGY UTILIZATION FOR DRAFT



44	College of Agriculture	The Role of Technology in Shaping the Future of Oil Production and Consumption	https://www.researchgate.net/profile/Khawla-Rashige/publication/345392828_The_Role_of_Technology_in_Shaping_the_Future_of_Oil_Production_and_Consumption/links/5fa5a9f292851cc2869ccc1b/The-Role-of-Technology-in-Shaping-the-Future-of-Oil-Production-and-Consumption.pdf
45	College of Agriculture	A First Record of Proteus hauseri and Pseudomonas putida Isolated from Common Carp (Cyprinus carpio) Cultivated in Floating Cages at Al-Hilla River, Babylon Province, Iraq: Antibiotic Resistance, Biological and Applied Environmental Research, 4(1): 25-33.	https://www.baerj.com/4(1)/Al-Niaem et al. 4 (1), 25-33, 2020.pdf
46	College of Agriculture	Impacts of Saltwater Intrusion on the Fish Assemblage in the Middle Part of Shatt Al-Arab River, Iraq	https://pdfs.semanticscholar.org/b0a9/032491e63e8e14c912ef3845c048805d6f6c.pdf
47	College of Agriculture	Evaluation of water quality on some wells in Basrah Governate for irrigation purposes	https://www.jam.utq.edu.iq/index.php/main/article/view/26
48	College of Agriculture	Study of morphological, chemical and physical properties of soils affected by salts using the techniques of remote	https://faculty.uobasrah.edu.iq/uploads/publications/1612811137.pdf

UNIVERSITY OF BASRAH SUSTAINABILITY REPORT



		sensing and geographic information systems in Basra Governorate	
49	College of Agriculture	MOVEMENT OF WATER AND SALT ACCUMULATION IN SOIL AS EFFECTED BY EMULSIFIED AND UN-EMULSIFIED CRUDE OIL	http://plantarchives.org/20-1/229-243.(5401).pdf
50	College of Agriculture	Effect of Irrigation Water Quality and Spraying with Tocopherol on Na, K, K ⁺ /Na ⁺ and Cl ⁻ and Chemical Components of Okra (<i>Abelmoschus esculentus</i> L. Moench)	https://www.researchgate.net/profile/Awatif-Jerry/publication/344612003_Effect_of_Irrigation_Water_Quality_and_Spraying_with_Tocopherol_on_Na_K_KNa_and_Cl-and_Chemical_Components_of_Okra_Abelmoschus_esculentus_L_Moench/links/5f84651f92851c14bcc17f0e/Effect-of-Irrigation-Water-Quality-and-Spraying-with-Tocopherol-on-Na-K-K-Na-and-Cl-and-Chemical-Components-of-Okra-Abelmoschus-esculentus-L-Moench.pdf
51	College of Agriculture	Evaluation the efficacy of nano-fertilization and Disper osmotic in treating salinity of irrigation water in quality and productivity properties of date palm <i>Phoenix dactylifera</i> L.	https://iopscience.iop.org/article/10.1088/1755-1315/388/1/012072/meta
52	College of Agriculture	Evaluation of the Effect of Nano-Fertilization and Disper Osmotic in Treating the Salinity of Irrigation Water on the Chemical and Mineral Properties of Date Palm (<i>Phoenix dactylifera</i> L. (https://bjas.bajas.edu.iq/index.php/bjas/article/view/176

UNIVERSITY OF BASRAH SUSTAINABILITY REPORT



53	College of Agriculture	The Effect of Environmental Stress on the Protein Pattern of Gladiolus Spp.	https://iopscience.iop.org/article/10.1088/1755-1315/388/1/012066/meta
54	College of Agriculture	Study on chemical changes and microbiological pollution in cooked meats on display in some local restaurants in Basra province	https://scholar.google.com/citations?user=EGcxxXoAAAJ&hl=en
55	College of Agriculture	Comparison Of Different Types Of Protein Concentrates In Female Japanese Quail Diets And Study Their Effect On Some Production And Sensory Characteristics	https://basjvet.org/uploads/pdf/1589061814.pdf
56	College of Agriculture	Harmful effect of toxins on poultry	https://www.malque.org/ojs/index.php/mr/article/view/64
57	College of Agriculture	Detection of microbe contamination and heavy metals in cooked poultry meat displayed in local markets in Basra province, Iraq	http://agri-research-journal.net/?p=2826
58	College of Agriculture	The Effect of Nutrition on Immune System Review Paper	https://www.researchgate.net/profile/Poonam-Kharangarh/post/What-can-we-do-to-enhance-the-Immunity/attachment/5f75fe857600090001eb6e25/AS%3A941860243656705%401601568389498/download/Effect+of+Nutrition.pdf

UNIVERSITY OF BASRAH SUSTAINABILITY REPORT



59	College of Agriculture	Anticancer Drugs as a Model for Destroying and Reducing the Growth of Human Breast MDA-MB231 Cancer Cells	https://www.researchgate.net/profile/Raghdan-Mohsin-2/publication/338137106_Anticancer_Drugs_as_a_Model_for_Destroying_and_Reducing_the_Growth_of_Human_Breast_MDA-MB231_Cancer_Cells/links/6047edae299bf1e0786959aa/Anticancer-Drugs-as-a-Model-for-Destroying-and-Reducing-the-Growth-of-Human-Breast-MDA-MB231-Cancer-Cells.pdf
60	College of Agriculture	Economically Importance Insects of the Plantations in Basrah Province, Iraq	https://www.researchgate.net/profile/Aqeel-Alyousuf/publication/341779031_Economically_Important_Insects_of_the_Plantations_in_Basrah_Province_Iraq/links/5edff823a6fdcc4768942c1e/Economically-Important-Insects-of-the-Plantations-in-Basrah-Province-Iraq.pdf
61	College of Agriculture	Pollutants: issues and challenges in public safety	http://ecologyresearch.info/documents/EC0690.pdf
62	College of Agriculture	Scanning of processed food contaminating fungi and determine the potential Aflatoxigenic type	https://bjas.bajas.edu.iq/index.php/bjas/article/view/101

UNIVERSITY OF BASRAH SUSTAINABILITY REPORT



63	College of Pharmacy	Supplementary Materials to Impact of Processing Parameters on the Quality of Pharmaceutical Solid Dosage Forms Produced by Fused Deposition Modeling (FDM)	https://www.mdpi.com/1999-4923/11/12/633
64	College of Pharmacy	Effects of chronic use of medicines on clinical outcomes of Covid-19 patients in Basrah Province.	https://ejmcm.com/article/4946_fc60ed284fd9eaf5a6908b97c4623591.pdf
65	College of Pharmacy	Solid Lipid Nanoparticle (SLN) as a Novel Drug Delivery System : A theoretical Review	https://www.researchgate.net/profile/Ahmed-Alsaad-3/publication/342039212_Solid_Lipid_Nanoparticles_SLN_as_a_Novel_Drug_Delivery_System_A_Theoretical_Review/links/5edf4bec299bf1d20bdb0864/Solid-Lipid-Nanoparticles-SLN-as-a-Novel-Drug-Delivery-System-A-Theoretical-Review.pdf
66	College of Pharmacy	Impacts of COVID-19 Pandemic on Iraqi Healthcare Providers	https://www.ncbi.nlm.nih.gov/pmc/articles/PMC8135993/
67	College of Pharmacy	Antibiotic Susceptibility Manner of the bacteria causes Urinary tract Infections in basra, South Iraq	https://faculty.uobasrah.edu.iq/uploads/publications/1605676515.pdf
68	College of Pharmacy	Hypolipidemic and Antioxidant Effects of Fenugreek- Nigella Sativa Combination on Diabetic patientsin Iraq	http://search.ebscohost.com/login.aspx?direct=true&profile=ehost&scope=site&authtype=crawler&jrnl=097

UNIVERSITY OF BASRAH SUSTAINABILITY REPORT



			58453&AN=144464250&h=Xv5N%2FWlabtd6vR9f2Pof3Lul2cdGZ6sJFm99%2B8Skz3cyKMRKvGiLpNkucqZ2yrBnsN%2FF00XjQa7oxoOCCg%2FvQ%3D%3D&crl=c
69	College of Pharmacy	Detrimental effects of social lockdown and quarantine due to Covid _ 19 pandemic on human health aspects. Review article	https://search.bvsalud.org/global-literature-on-novel-coronavirus-2019-ncov/resource/en/covidwho-1090067
70	College of Pharmacy	Community pharmacist perception of clinical services pharmacy function	http://www.pharmacy.uobasrah.edu.iq/images/project/2017_2018/clinical/COMMUNITYPHARMACISTS PERCEPTION OF CLINICAL SERVICE PHARMACY FUNCTION.pdf
71	College of Pharmacy	The development of analytical methods to determine metochlopramide-hydrochloric acid in the strand raw and it compared with pharmaceuticals	https://faculty.uobasrah.edu.iq/uploads/publications/1613159739.pdf
72	College of Pharmacy	Assessment of Dosing Errors in pediatric Patients prescriptions in Basra City	https://www.researchgate.net/profile/Noor-Kad/publication/343290784_Original_Article/links/5f218fd2a6fdcccc43966d54/Original-Article.pdf

UNIVERSITY OF BASRAH SUSTAINABILITY REPORT



73	College of Medicine	Bacteriological Assessment of Tap Water and Two Types Of Bottled Drinking Water Available At Basra City, South Of Iraq	https://www.researchgate.net/publication/335988935
74	College of Medicine	Epidemiological Features of COVID-19 Epidemic in Basrah - southern Iraq - First report	https://iraqjournals.com/article_164544_0.html
75	College of Medicine	The dynamics of COVID-19 Epidemic in Basrah - province -Second report	https://iraqjournals.com/article_165376_0.html
76	College of Medicine	Bacterial contamination associated with mobile phones used by students at Basrah Medical College, Basrah, Iraq	
77	College of Medicine	Bacterial contamination associated with mobile phones used by students at Basrah Medical College, Basrah, Iraq	https://mjbu.uobasrah.edu.iq/article_165380_en.html
78	College of Medicine	Knowledge and practice of adults attending primary health care centers regarding major coronary haert disease risk factors in Basrah city	https://www.iraqjournals.com/article_165440_0.html
79	College of Medicine	Changes in Electrolyte Ions Level in Healthy and Osteoporosis women in Basra Province/ Iraq	https://www.researchgate.net/profile/Mustafa-Hussein-22/publication/330514030

UNIVERSITY OF BASRAH SUSTAINABILITY REPORT



80	College Of Science	Pyrene-Degrading Fungus <i>Ceriporia Lacerata</i> RF-7 From Contaminated Soil In Iraq	https://www.tandfonline.com/doi/abs/10.1080/10406638.2020.1713183
81	College Of Science	Distribution Of Heavy Metals In Coral Skeleton And Ambient Seawater : Southern Iraq	http://search.ebscohost.com/login.aspx?direct=true&profile=ehost&scope=site&authtype=crawler&jrnl=18357156&AN=144393825&h=Y5nbL1SURmTOkVjbf9iebQb4G5oUIO3vw578xgEU965t3Xe8iM9To1Ogaenfu%2FuTzrV7FBV2lu%2F1AXzpjKyZGA%3D%3D&crl=c
82	College Of Science	Comparison The BED Sediment Contamination Of The Southern Part Of Euphrates River With Shatt AL-ARAB , Iraq	http://igi-iraq.org/igi/index.php/igi/article/view/153
83	College Of Science	Some Of Heavy Elements In Water , Fish And Plant Species From Shatt Al-Arab At Basrah Governorate – Iraq	http://basjsci.net/index.php/bsj/article/view/65
84	College Of Science	Assessment Of Heavy Metals Of Heavy Metals Contamination And Sediment Quality In Shatt Al-Arab River , S Iraq	https://igi-iraq.org/igi/index.php/igi/article/view/22
85	College Of Science	A GIS-Based SINTACS Model For Assessing Intrinsic Groundwater Vulnerability Of The Alton Kopri Basin, Kirkuk Governorate Northeast Of Iraq.	https://iopscience.iop.org/article/10.1088/1742-6596/1294/8/082004/meta
86	College Of Science	Marshes Waters Sources Hydrochemistryof The Bahr Al-Najaf At Najaf Province, Iraq	https://iopscience.iop.org/article/10.1088/1742-6596/1279/1/012059/meta

UNIVERSITY OF BASRAH SUSTAINABILITY REPORT



87	College Of Science	Hydrogeochemical Modeling And Isotopic Assessment Of The Quaternary Aquifer At Ali Al-Garbi Area In Misaan Governorate, South Of Iraq	https://link.springer.com/chapter/10.1007/978-3-030-01572-5_30
88	College Of Science	Marshes Waters Sources Hydrochemistryof The Bahr Al-Najaf At Najaf Province, Iraq	https://iopscience.iop.org/article/10.1088/1742-6596/1279/1/012059/meta
89	College Of Science	Evaluating The Dibdibba Aquifer Productivity At The Karbala–Najaf Plateau (Central Iraq) Using GIS-Based Tree Machine Learning Algorithms	https://link.springer.com/article/10.1007/s11053-019-09561-x
90	College Of Science	A GIS-Based SINTACS Model For Assessing Intrinsic Groundwater Vulnerability Of The Alton Kopri Basin, Kirkuk Governorate Northeast Of Iraq.	https://iopscience.iop.org/article/10.1088/1742-6596/1294/8/082004/meta
91	College of Law	Optimizing your holiday : A proposal for the optimal system for timesharing from a comparative perspective.	https://scholar.google.com/citations?user=mXReg1IAAAA&hl=en
92	College of Law	معوقات تقديم المساعدات الانسانية في القانون الدولي الانساني	https://faculty.uobasrah.edu.iq/faculty/1172/publications
93	College of Law	العلاقة الدولية بين إدارة الازمة وإشاعة الفوضى	https://scientificjournal.alqalam.edu.iq/ojs/index.php/AQJ/article/view/41

UNIVERSITY OF BASRAH SUSTAINABILITY REPORT



94	College of Engineering	Sustainable manufacturing process applied to produce magnesium oxide from sea water	https://iopscience.iop.org/article/10.1088/1757-899X/757/1/012021/meta
95	College of Engineering	Study of enhancing thermo-hydraulic performance of turbulent flow inside a tube occupied with central cut twisting tapes.	http://www.jeng.utq.edu.iq/index.php/main/article/view/247
96	College of Engineering	Performance evaluation of the characteristics of flow and heat transfer in a tube equipped with twisted tapes of new configurations.	https://www.sciencedirect.com/science/article/pii/S1290072919309032
97	College of Engineering	Pyrene-Degrading Fungus Ceriporia lacerata RF-7 from Contaminated Soil in Iraq	https://www.tandfonline.com/doi/abs/10.1080/10406638.2020.1713183
98	College of Engineering	Fabrication of double-sided comb-like F/Ce co-doped BiVO ₄ micro/nanostructures for enhanced photocatalytic degradation and water oxidation	https://link.springer.com/article/10.1007/s11051-020-04792-z
99	College of Engineering	Recycling the waste of paper into usable board	https://aip.scitation.org/doi/abs/10.1063/5.0000205
100	College of Engineering	Drought Hazard Assessment in Iraq using SPI and GIS Systems	https://www.researchgate.net/profile/Ahmed-A-Hamdan/publication/337935497_Drought_Hazard_Assessment_in_Iraq_using_SPI_and_GIS_Systems/links/5df54e194585159aa47e98b4/Drought-Hazard-

UNIVERSITY OF BASRAH SUSTAINABILITY REPORT



			Assessment-in-Iraq-using-SPI-and-GIS-Systems.pdf
101	College of Engineering	Assessment of heavy metals pollution in the Shatt Al-Arab River, Basra-Iraq	https://aip.scitation.org/doi/abs/10.1063/5.0000300
102	College of Engineering	Evaluation of Water Treatment Plants Quality in Basra province, by Factor and Cluster Analysis	https://yadda.icm.edu.pl/baztech/element/bwmeta1.element.baztech-bf565518-2a4d-49ad-aa82-4be4a5619fbb
103	College of Engineering	applicatiin HECRAS model to simulate the flood wave due to dam failure	https://ieeexplore.ieee.org/abstract/document/9019369/
104	College of Engineering	Geotechnical Features of Basrah City, Iraq	https://www.researchgate.net/profile/Ihsan-Al-Abboodi/publication/339827161_Geotechnical_Features_of_Basrah_City_Iraq/links/5e679cc092851c7ce059176f/Geotechnical-Features-of-Basrah-City-Iraq.pdf
105	College of Engineering	ESTIMATION OF GROUNDWATER RECHARGE IN SAFWAN-ZUBAIR AREA, SOUTH OF IRAQ, USING WATER BALANCE AND INVERSE MODELING METHODS	https://www.academia.edu/download/61614996/IJCIET_10_09_02120191226-51671-16j9f0c.pdf
106	College of Engineering	Assessment of water quality of Garmat Ali river for irrigation purposes	https://www.e3s-conferences.org/articles/e3sconf/abs/2019/44/e3sconf_icaeer18_03054/e3sconf_icaeer18_03054.html

UNIVERSITY OF BASRAH SUSTAINABILITY REPORT



107	College of Engineering	A Comparative Study of Adaptive Neuro Fuzzy Inference System and Artificial Neural Networks for Predicting Groundwater Hydraulic Head in an Arid Region	https://journalofbabylon.com/index.php/JUBES/article/view/2801
108	College of Engineering	Assessment of Groundwater Vulnerability Using Lucl Map and DRASTIC Technique in Bahr AL-Najaf Area, Middle of Iraq	http://www.tj-es.com/wp-content/uploads/2019/vol26/no3/vol26no3p1.pdf
109	College of Engineering	Estimation of Spatial Groundwater Recharge Using Wetspass Model in Teeb Area, Missan Province, South of Iraq	https://www.researchgate.net/profile/Ali-Al-Aboodi/publication/354688041_Groundwater_Vulnerability_Assessment_by_Using_Drastic_and_God_Methods/links/614707c0a3df59440b984ac3/Groundwater-Vulnerability-Assessment-by-Using-Drastic-and-God-Methods.pdf
110	College of Engineering	Modification of DRASTIC Vulnerability Technique for Groundwater in Bahr AL-Najaf Area, Middle of Iraq	https://www.researchgate.net/profile/Ali-Al-Aboodi/publication/343979950_Modification_of_DRASTIC_Vulnerability_Technique_for_Groundwater_in_Bahr_AL-Najaf_Area_Middle_of_Iraq/links/5f4bbbc8b92851c6cfd027f99/Modification-of-DRASTIC-Vulnerability-Technique-for-Groundwater-in-Bahr-AL-Najaf-Area-Middle-of-Iraq.pdf
111	College of Engineering	Design criteria for presedimentation basin treats: Shatt Al-Arab River water	https://kuwaitjournals.org/jer/index.php/JER/article/view/7346

UNIVERSITY OF BASRAH SUSTAINABILITY REPORT



112	College of Engineering	Improving Collapsibility and Compressibility of Gypseous soil using Cement Material	https://www.journalofbabilon.com/index.php/JUBES/article/view/2940
113	College of Engineering	The use of horizontal flow constructed wetland for treatment of sanitary wastewater in Iraq	https://faculty.uobasrah.edu.iq/uploads/publications/1621102137.pdf
114	College of Engineering	The use of multivariate statistical techniques in the assessment of river water quality	https://www.iasj.net/iasj/article/183496
115	College of Engineering	Design and Construction a Falling Water Digital Display System	https://www.researchgate.net/profile/Abdulmuttalib-Rashid/publication/337293529
116	College of Engineering	Multi-Robot Localization System using an Array of LEDs and LDR Sensors	http://faculty.uobasrah.edu.iq/uploads/publications/1612908815.pdf
117	College of Engineering	Radioactive Pollution Studies for Soil Samples in the South of Basra Province	https://aip.scitation.org/doi/abs/10.1063/5.0000293
118	College of Engineering	Full Width-Half Maximum Characteristics of FBG for Petroleum Sensor Applications,	http://ijeee.edu.iq/Papers/Vol16-Issue1/1570643986.pdf
119	College of Engineering	Hydrodynamics Behaviour of Single and Multi Fracture with Different Orientations in Petroleum Reservoir,	https://www.researchgate.net/profile/Amani-Al-Husseini/publication/345312861
120	College of Engineering	Correlated Friction Reduction and Viscoelastic Characterization of Utilizing	https://onepetro.org/SPEA-DIP/proceedings-abstract/19ADIP/4-

UNIVERSITY OF BASRAH SUSTAINABILITY REPORT



		the Permian Produced Water with HVFRs during Hydraulic Fracturing,	19ADIP/D041S120R002/216525
121	College of Engineering	Correlated Friction Reduction and Viscoelastic Characterization of Utilizing the Permian Produced Water with HVFRs during Hydraulic Fracturing	https://onepetro.org/SPEA-DIP/proceedings-abstract/19ADIP/4-19ADIP/D041S120R002/216525
122	College of Engineering	New Opportunities and Challenges to Discover and Develop Unconventional Plays in the Middle East and North Africa: Critical Review,	https://onepetro.org/SPEA-DIP/proceedings-abstract/19ADIP/3-19ADIP/D031S072R003/216823
123	College of Engineering	Highlights of the novel dewaterability estimation test (DET) device	https://www.tandfonline.com/doi/abs/10.1080/09593330.2019.1575916
124	College of Engineering	Phytoremediation performance of floating treatment wetlands with pelletized mine water sludge for synthetic greywater treatment	https://link.springer.com/article/10.1007/s40201-019-00372-z
125	College of Engineering	Biochemical performance modelling of non-vegetated and vegetated vertical subsurface-flow constructed wetlands treating municipal wastewater in hot and dry climate	https://www.sciencedirect.com/science/article/pii/S214714419309079
126	College of Engineering	Impact of Storage Time on Characteristics of Synthetic Greywater for Two Different Pollutant Strengths to Be Treated or Recycled	https://link.springer.com/article/10.1007/s11270-020-04602-1

UNIVERSITY OF BASRAH SUSTAINABILITY REPORT



127	College of Engineering	Design Health care system using Raspberry Pi and ESP32	https://www.semanticscholar.org/paper/Design-Health-care-system-using-Raspberry-Pi-and-Qunoot-A./e5f6567921afe7485ef445a932b99b7e998dfe0d
128	College of Engineering	Self-Organization of Multi-Robot System Based on External Stimuli	https://www.iasj.net/iasj/download/3dcf86aeb442d0b8
129	College of Engineering	Epidemiological Characteristics of COVID-19 Ongoing Epidemic in Iraq	https://www.who.int/bulletin/online_first/20-257907.pdf
130	College of Engineering	Design of pitch angle controller for wind turbine based on pi neurofuzzy model	https://www.researchgate.net/profile/Mofeed-Rashid/publication/334544306
131	College of Engineering	Navigation of Mini Unmanned Aerial Vehicle in Unknown Environment	https://iopscience.iop.org/article/10.1088/1757-899X/745/1/012014/meta
132	College of Engineering	Control Strategy of Reactive Power Sharing in an Islanded Microgrid	http://ijeee.edu.iq/Papers/SCEEER-3RD/1570645262.pdf
133	College of Engineering	Integrated solar still with an underground heat exchanger for clean water production	https://www.sciencedirect.com/science/article/pii/S1018363918311905
134	College of Marine Sciences	Heavy elements accumulation in dominants aquatic plants at Al-Chibayish Marshes, South of Iraq	https://faculty.uobasrah.edu.iq/uploads/publications/1611598731.pdf

UNIVERSITY OF BASRAH SUSTAINABILITY REPORT



135	College of Marine Sciences	Study of concentration of some trace elements in the euphrates river water in al-muthanna governorate, iraq	https://www.researchgate.net/profile/Hamid-Al-Saad/publication/339339269_STUDY_OF_CONCENTRATION_OF_SOME_TRACE_ELEMENTS_IN_THE_EUPHRATES_RIVER_WATER_IN_AL-MUTHANNA_GVERNORATE_IRAQ/links/5e4c35a992851c7f7f4562fb/STUDY-OF-CONCENTRATION-OF-SOME-TRACE-ELEMENTS-IN-THE-EUPHRATES-RIVER-WATER-IN-AL-MUTHANNA-GVERNORATE-IRAQ.pdf
136	College of Marine Sciences	Heavy Minerals Distribution and Provenance in Palinurus Shoal, Northwest of the Arabian Gulf	http://basjsci.net/index.php/bsj/article/view/86
137	College of Marine Sciences	Hydrodynamic of the Sediments Movement in the Southern Part of the Shatt al-Arab and North-Western of the Gulf	https://www.researchgate.net/profile/Usama-Al-Whaely/publication/336013995_Hydrodynamic_of_the_Sediments_Movement_in_the_Southern_Part_of_the_Shatt_al-Arab_and_North-Western_of_the_Gulf/links/5d8a7ece299bf10cff0b12d4/Hydrodynamic-of-the-Sediments-Movement-in-the-Southern-Part-of-the-Shatt-al-Arab-and-North-Western-of-the-Gulf.pdf
138	College of Marine Sciences	Mineralogy and Sediment Grain-Size Distributions as index of the modern sedimentary processes of Sawa Lake, Mothanna Governorate, Southwestern Iraq	https://faculty.uobasrah.edu.iq/uploads/publications/1610888784.pdf
139	College of Marine Sciences	Using GIS and remote sensing satellite data to mapping and monitoring Shatt Al-	https://www.researchgate.net/profile/Usama-Al-Whaely/publication/342889628

UNIVERSITY OF BASRAH SUSTAINABILITY REPORT



		Arab estuary and nearby conastline southern Iraq	Using GIS and Remote Sensing Satellite Data to mapping and monitoring Shatt Al-Arab Estuary and nearby coastline Southern Iraq/links/5f0c472d4585155a55250169/Using-GIS-and-Remote-Sensing-Satellite-Data-to-mapping-and-monitoring-Shatt-Al-Arab-Estuary-and-nearby-coastline-Southern-Iraq.pdf
140	Presidency University	Effect of glutathione (GSH) on Date palm (Phoenix dactylifera L.) micropropagation	http://ife.sk/wp-content/uploads/2016/10/foecol-2020-0008.pdf
141	Presidency University	The effect of cytokines and oxenate on the growth and rooting of the vegetable branches of phoenix dactylifera L dates palms. The milky and blond outside the living body.	https://search.emarefa.net/ar/detail/BIM-971759
142	Presidency University	Study of the effect of jasmonic acid and salslike in chemical traits and the genetic stability of date palm fluids under salt stress	https://www.iasj.net/iasj/download/f692c5cadb5f1d7c
143	Presidency University	Assessment of protictive mechanisms against ultra violate-B stress on tow species of palms seedlings grown under laboratory conditions	http://journals.uokerbala.edu.iq/index.php/Agriculture/article/view/791
144	Presidency University	The effect of baclopotrazole and casein in the protein pattern of the vegetative embryos of phoenix dactylifera L. Nersi Class	https://www.researchgate.net/publication/331208321

UNIVERSITY OF BASRAH SUSTAINABILITY REPORT



145	Presidency University	Change in photosynthetic pigments of Date palm offshoots under abiotic stress factors	https://faculty.uobasrah.edu.iq/uploads/publications/1599399959.pdf
146	Presidency University	Photooxidative Stress Modulation of Endogenous Phytohormone and Antioxidant Accumulations and Fruit Maturity in Date Palm	https://link.springer.com/article/10.1007/s00344-020-10180-7
147	Presidency University	Effect of Salicylic Acid on Antioxidant Enzymes and Biochemical Contents of Date Palm Plantlets (Phoenix dactylifera L.) under Salt Stress Conditions	https://www.indianjournals.com/ijor.aspx?target=ijor:ije1&volume=47&issue=2&article=021
148	Presidency University	Appearance characterization and vital indicators of seed strains of date palms	https://www.iasj.net/iasj/download/dd9779d556b8371a
149	Presidency University	Measuring the level of psychological rebellion in secondary schools from the point of view of teachers	https://www.journalofbabylon.com/index.php/JUBH/article/view/3024
150	Presidency University	The most important problems arising from changes in the curriculum from the point of view of teachers	https://search.emarefa.net/ar/detail/BIM-974137
151	Presidency University	Following the learning strategy focused on understanding the problem and its relationship to the study in the subject of teaching methods among students of the Faculty of Education for Pure Sciences	https://academia-arabia.com/ar/reader/2/97047
152	Presidency University	Application of GIS technologies to estimate the amount of solar energy in	https://search.mandumah.com/Record/1063613

UNIVERSITY OF BASRAH SUSTAINABILITY REPORT



		Basra province and the possibilities of its use in desalination of seawater	
153	Presidency University	Applied solutions to address informal housing in Basra	https://search.emarefa.net/ar/detail/BIM-977790-%D8%A7%D9%84%D8%AD%D9%84%D9%88%D9%84-%D8%A7%D9%84%D8%AA%D8%B7%D8%A8%D9%8A%D9%82%D9%8A%D8%A9-%D9%84%D9%85%D8%B9%D8%A7%D9%84%D8%AC%D8%A9-%D8%A7%D9%84%D8%B3%D9%83%D9%86-%D8%A7%D9%84%D8%B9%D8%B4%D9%88%D8%A7%D8%A6%D9%8A-%D9%81%D9%8A-%D9%85%D8%AF%D9%8A%D9%86%D8%A9-%D8%A7%D9%84%D8%A8%D8%B5%D8%B1%D8%A9
154	Presidency University	Tourism development and its economic importance in Iraq / Joint research with: Astbarq Abdul Hussein Salman	https://www.asjp.cerist.dz/en/article/140017
155	Presidency University	Iraq in light of good governance indicators	https://www.asjp.cerist.dz/en/article/136430
156	Presidency University	The Role of Foreign Investment in Developing Iraq Economy with Reference to Basrah Governorate	https://www.iasj.net/iasj/download/9bed2f042d0723b2
157	Presidency University	The role of the geographical researcher in solving contemporary environmental problems (pollution of the internal rivers in Basra city as a model")	https://books.google.iq/books?hl=ar&lr=&id=4ZokDwAAQBAJ&oi=fnd&p=g=PT2&dq
158	Presidency University	Contradiction of water flows in Basra province: reasons and solutions	https://www.hrw.org/ar/news/2019/07/22/331730

UNIVERSITY OF BASRAH SUSTAINABILITY REPORT



159	Presidency University	The strategic importance of the Strait of Hormuz in the U.S.-Iran conflict in the Arabian Gulf region.	https://meu.edu.iq/libraryTheses/ /%D8%A7 %D9%84%D8%A3%D9%87%D9%85 5%D9%8A %D8%A9%20%D8%A7%D9%84%D 8%A7%D8 B3%D8%AA%D8%B1%D8%A7%D8 %AA%D9%8 A%D8%AC%D9%8A%D8%A9%20 %D9%84%D 9%85%D8%B6%D9%8A%D9%82% 20%D9%87%D8 %B1%D9%85%D8%B2%20%D9%8 8%D8%A7%D9%86% D8%B9%D9%83%D8%A7%D8%B3 % D8%A7%D8%AA%D9%87%D8%A7 %20%D8%B9 %D9%84%D9%89%20%D8%A7%D 9%84%D8%A3% D9%85%D9%86.pdf
160	Presidency University	The characteristics of the river basin water system and its impact on the density of drainage (Wadi Al-Akhira Model)(https://www.iasj.net/iasj/ download/d0cdd9100a217 446
161	Presidency University	The natural characteristics of wadi Diwana basin in eastern Iraq and its impact on the distribution of sediments	http://eps.mu.edu.iq/wp- content/uploads/2017/02/%D8 A7%D9%84%D 8%AA%D8%AD%D9%84%D9%8A %D9%84- %D8%A7%D9%84%D9%85%D9%8 8%D8%B1%D9 %81%D9%88%D9%85%D8%AA%D 8%B1%D9%8A- %D9%84%D9%88%D8%A7%D8%A F%D9%8A- %D9%82%D8%B1%D9%8A%D9%8 6- %D8%A7%D9%84%D8%AB%D9% 85%D8%A7%D8%AF.pdf







6. 2. 2. Sustainability patents in 2019/2020





6. 3. Some of Sustainability events during 2019 / 2020

Below is a schedule of important seminars, courses and events that took place in 2019/2020 related to sustainability:

	Event	Link
1	 <p data-bbox="358 1142 1073 1230">University of Basrah holds scientific seminar on Corona virus</p>	<p data-bbox="1143 863 1422 1058"> https://www.facebook.com/pharmacy99/posts/1257804847746569 </p>
2	 <p data-bbox="329 1734 1105 1822">University of Basrah organizes WHO thank-you vigil in Basrah</p>	<p data-bbox="1143 1423 1422 1562"> https://pharmacy.uobasrah.edu.iq/index.php/news/21 </p>



<p>3</p>		<p>University of Basrah holds ceremony to honor a number of journalists and press institutions</p>	<p>https://pharmacy.uobasrah.edu.iq/archive/9639</p>
<p>4</p>	<p>University of Basrah holds a ceremony to honor the scientific team prepared and produced for the transporter center</p>		<p>https://uobasrah.edu.iq/news/340</p>
<p>5</p>		<p>University of Basrah organizes workshop entitled Using Google Models to Add Students to Virtual Classes</p>	<p>https://uobasrah.edu.iq/colleges-news/246</p>





<p>6</p>	<p>In cooperation with the International Pulse Center and the Jordan Research and Development Center, according to the American Heart Association's curriculum, an electronic workshop entitled "First Aid"</p>	<p>https://www.uobasrah.edu.iq/news/397</p>
<p>7</p>	<p>University of Basrah organizes workshop on moanddel program</p>	<p>http://uobasrah.edu.iq/news/456</p>
<p>8</p>	<p>University of Basrah, in collaboration with the World Health Organization (WHO) and forensic evidence in</p>	<p>https://uobasrah.edu.iq/news/235</p>



		<p>Basra, organizes a workshop on RT-PCR examinations</p>	
<p>9</p>		<p>University of Basrah announces five patents to cope with pandemic Sk</p>	<p>https://uobasrah.edu.iq/news/248</p>
<p>10</p>	<p>University of Basrah organizes electronic lecture in partnership with Johns Hopkins University on the new Corona Virus</p>	<p>https://uobasrah.edu.iq/news/384</p>	
<p>11</p>		<p>University of Basrah holds seminar on e-learning platform applications)moodle(</p>	<p>https://uobasrah.edu.iq/news/400</p>



<p>12</p>		<p>University of Basrah organizes an electronic workshop on how to face anxiety and stress to protect your immune system</p>	<p>https://contin.uobasrah.edu.iq/archive/9153</p>
<p>13</p>		<p>University of Basrah organizes an electronic workshop on the role of student and university professor in e-education</p>	<p>https://www.uobasrah.edu.iq/news/394</p>
<p>14</p>		<p>University of Basrah holds seminar on the development of Corona virus and its impact on molecular diagnosis</p>	<p>https://med.uobasrah.edu.iq/news/2533</p>



15



WHO supplies raw materials to University of Basrah for co-virus-carrying medium production

<https://uobasrah.edu.iq/news/85>

16



WHO documents scientific output of research team at University of Basrah producing vector implants

<https://uobasrah.edu.iq/news/101>

17



University of Basrah organizes training course entitled "Let's break the corona virus infection series"

<https://www.uobasrah.edu.iq/news/422>



<p>18</p>	<p>جامعة البصرة مركز التطوير المستمر الدور الثاني ارباعي .. لا تونر</p> <p>برعاية السيد رئيس جامعة البصرة أ.د.سعد شاheen حمادي المحترم يقوم مركز التطوير المستمر نموذجية أكاديمية إلكترونية موسعة حول المشكلات التدريسية في الجامعات (العراقية (البصرة نموذجاً) في ضوء دراسة مسجعة شاملة وذلك في تمام الساعة التاسعة مساءً من يوم الخميس المصادف 7/3/2020 بمشاركة كل من أ.م.عبد الجبار عبد الله يعقوب أ.م.عبد الواحد محمود محمد أ.م.جمال عبد الرزاق روجم أ.م.د.عبد. توفيق محمد أ.د.ن.عبد. محمد باقر</p> <p>بمدير الدعوة : المدرس كاظم عبد العزيز طلاق ID OF FREE CONFERENCE CALL : keyanalsibahi3</p> <p>ملاحظة : يتم إرسال رابط التسجيل أثناء المحاضرة ويشترك كتابة الاسم الآلي باللغة العربية حصراً رابط قناة المركز على التليجرام HTTPS://T.ME/CCADU</p>	<p>University of Basrah organizes scientific seminar on academic teaching problems</p>	<p>https://contin.uobasrah.edu.iq/archhive/9147</p>
<p>19</p>	<p>جامعة البصرة مركز التطوير المستمر الدور الثاني ارباعي .. لا تونر</p> <p>برعاية السيد رئيس جامعة البصرة أ.د.سعد شاheen حمادي المحترم يقوم مركز التطوير المستمر وبالتنسيق مع جامعة بغداد كلية التربية ابن رشد شعبة إلكترونية بعنوان على الهواء مباشرة .. طالب الدراسات العليا والاساتذ ومشكلات التعليم الإلكتروني وتوصيات للحد منها وذلك في تمام الساعة التاسعة مساءً من يوم الطلاثاء المصادف 3٠٠٢/٢/١٩ بمشاركة كل من أ.د.د.عبد. محمد باقر أستاذ المناهج وطرائق التدريس أ.د.سعد علي زاهر أ.د.داود عبد السلام صموي أستاذ المناهج وطرائق التدريس أستاذ المناهج وطرائق التدريس</p> <p>ID OF FREE CONFERENCE CALL : NMBHMALY</p> <p>ملاحظة : يتم إرسال رابط التسجيل أثناء المحاضرة ويشترك كتابة الاسم الآلي باللغة العربية حصراً رابط قناة المركز HTTPS://T.ME/CCADU</p>	<p>University of Basrah organizes electronic seminar on graduate student, professor and e-learning problems</p>	<p>https://uobasrah.edu.iq/news/463</p>
<p>20</p>	<p>University of Basrah organizes an electronic course in the lecture industry with three highly professional programs</p>	<p>جامعة البصرة مركز التطوير المستمر برعاية السيد رئيس جامعة البصرة أ.د.سعد شاheen حمادي المحترم ويشرف مركز التطوير المستمر تقام ورشة إلكترونية بعنوان المحاضرات الإلكترونية من الأثناء على العرض على الانترنت يلقيها المدرس المساعد منذر علي هلال التميمي يومي الجمعة والسبت ٢٢ و٢٣/٥/٢٠٢٠</p> <p>الساعة ٩ مساءً ملاحظة : يتم إرسال رابط التسجيل أثناء المحاضرة ويشترك كتابة الاسم الآلي باللغة العربية حصراً رابط قناة المركز رابط التليجرام HTTPS://T.ME/CCADU</p> <p>التعليق المطلوب في الخدمة الإلكترونية FREE CONFERENCE CALL FCC ID MEETING : lecbasra12 classroom : b5phddn</p>	<p>https://uobasrah.edu.iq/news/474</p>



21



University of Basrah holds extensive meeting on electronic examinations for students

<http://uobasrah.edu.iq/news/484>

22



University of Basrah holds training course on e-learning

<https://uobasrah.edu.iq/news/491>

23



University of Basrah Organizes a workshop on the uses of a platform to learn education

<https://uobasrah.edu.iq/news/486>



<p>24</p>	<p>University of Basrah organizes a workshop on the class room program and how to manage and conduct tests</p>	<p>https://ve.uobasrah.edu.iq/archive/9289</p>
<p>25</p>	<p>University of Basrah organizes workshop on e-learning and how to deal with Edmodo educational platforms</p>	<p>http://avicenna.uobasrah.edu.iq/archive/9438</p>
<p>26</p>	<p>University of Basrah organizes training workshops for graduate students on the performance of electronic examinations on a google classroom platform</p>	<p>https://ceps.uobasrah.edu.iq/archive/10028</p>



27



University of Basrah organizes a workshop on (how to log in and how to use the Edmodo program used to take the electronic exam)

University of Basrah organizes a workshop on (how to log in and how to use

<https://www.uobasrah.edu.iq/news/524>

28



University of Basrah holds scientific seminar on post-Covid life 19

<https://uobasrah.edu.iq/news/529>

29



University of Basrah organizes course on e-exam instructions and steps for graduate students

<https://www.uobasrah.edu.iq/news/536>



<p>30</p>	<p>University of Basrah organizes a workshop on the mechanism of conducting tests on the education platform as google class room</p> 	<p>https://uobasrah.edu.iq/news/543</p>
<p>31</p>	 <p>University of Basrah organizes workshop on psychological stress under house stone</p>	<p>https://contin.uobasrah.edu.iq/archive/9184</p>
<p>32</p>	<p>WHO honors University of Basrah Scientific Cell for Corona Crisis Management and Innovative Research Team for Vector Media</p> 	<p>https://uobasrah.edu.iq/news/588</p>





33

<https://uobasrah.edu.iq/news/576>

WHO honors President of University of Basrah for outstanding role in combating Corona pandemic

University of Basrah organizes workshop on electronic examinations for students of primary

34

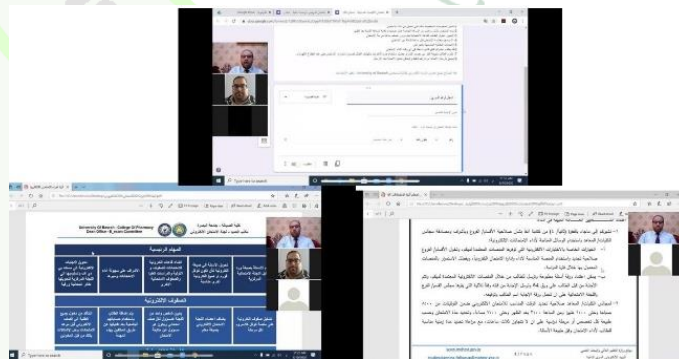

<https://uobasrah.edu.iq/colleges-news/274>



studies



<p>35</p>		<p>The Faculty of Pharmacy at University of Basrah held a panel discussion entitled "Does corona disease affect children?"</p>	<p>https://uobasrah.edu.iq/news/621</p>
<p>36</p>		<p>University of Basrah organizes workshop on how to find jobs and develop practical skills to enter the labor market</p>	<p>https://uobasrah.edu.iq/news/817</p>
<p>37</p>		<p>The aim of the work is to establish a qualitative laboratory for the digital oil field (real-</p>	<p>https://eng.uobasrah.edu.iq/news/1020</p>





	<p>time remote control - process automation - the use of artificial intelligence to process data), which ensures increased efficiency of oil processes such as drilling wells, ensures the safety of workers in this vital sector of the country, and reduces costs by providing a preventive system for potential problems, and many others.</p>	
<p>38</p>	 <p>University of Basrah organizes workshop on pressure management in the working environment</p>	<p>https://uobasrah.edu.iq/news/826</p>
<p>39</p>	 <p>University of Basrah organizes scientific seminar on human rights in light of corona spread</p>	<p>https://uobasrah.edu.iq/news/997</p>



40

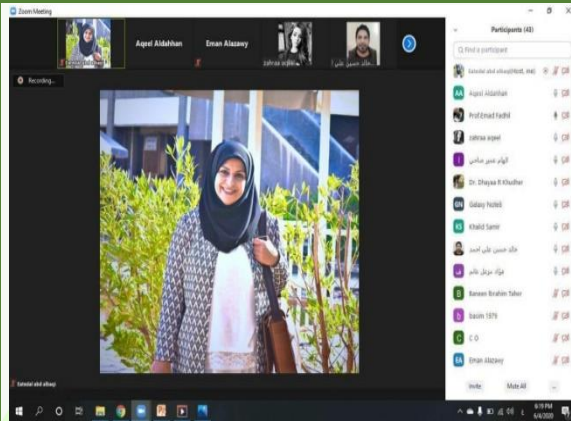

The Faculty of Law at University of Basrah organized an electronic workshop to clarify the

legal impact of the Corna pandemic on the legal periods of statute of limitations in Iraqi laws.

<https://law.uobasrah.edu.iq/archiv e/9426>

41



The Educational Guidance Unit at the Faculty of Law - University of Basrah held a seminar in the college on the role of e-learning in

overcoming the crisis of virus Corona presented by (A.M. Insam Faleh Hassan)

<https://uobasrah.edu.iq/news/109>



<p>42</p>		<p>University of Basrah School of Law organized a lecture on the impact of Eros Corona on the global economy</p>	<p>https://uobasrah.edu.iq/news/175</p>
<p>43</p>	<p>Battle of Badr</p>	<p>University of Basrah organizes international scientific seminar on the anniversary of the Great</p>	<p>https://uobasrah.edu.iq/news/393</p>
<p>44</p>		<p>University of Basrah organizes campaign together against epidemic on anniversary of University of Basrah</p>	<p>https://m.facebook.com/photo.php?fbid=1960327874266819&id=1380194472280165&set=a.1432192800413665</p>





45



<https://pharmacy.uobasrah.edu.iq/archive/9634>

University of Basrah trains cadres from Najaf Health Directorate and Al-Sponsor and Dean universities in the preparation and production of transportation and medical vehicles



6. 4. Student organizations on sustainability

Student organizations 1:

Engineers of hope is a volunteer team from the college of engineering students for helping orphans, elderly, and needy families.

<https://www.facebook.com/Engineers.of.hop>

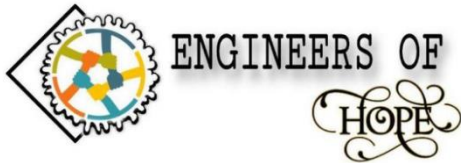

Student organizations 2:

Step of hope is a volunteer team from the 4th stage to college of medicine students to cooperate with nearby colleges to help people.

https://instagram.com/khatwat_amal?utm_medium=copy_link



Student organizations 3:

Tasnim Scouts organization is established in 2018 by group of multi college students. It is completely nonpolitical independent community service Non-Governmental





Organization. Tasnim goal to help building new voluntary generation who has good awareness. Tasnim activities include: awareness aspect, development, scouting, humanitarian, relief, and environment.

<https://www.facebook.com/%D8%AC%D9%85%D8%B9%D9%8A%D8%A9-%D9%83%D8%B4%D8%A7%D9%81%D8%A9-%D8%AA%D8%B3%D9%86%D9%8A%D9%85-102471634634493/>

[https://www.instagram.com/p/B7B8MijB61C/?utm_medium=copy link](https://www.instagram.com/p/B7B8MijB61C/?utm_medium=copy_link)

[https://www.instagram.com/p/B63sF8og_v/?utm_medium=copy link](https://www.instagram.com/p/B63sF8og_v/?utm_medium=copy_link)

[https://www.instagram.com/p/B-Sxlt4Bjym/?utm_medium=copy link](https://www.instagram.com/p/B-Sxlt4Bjym/?utm_medium=copy_link)

Student organizations 4:

IFMSA-Iraq team of officials 2020-2021 are driven by passion, motivation, and dedication to serve and develop our organization. During these tough times, we need solidarity, we need unity, and unique harmony between all our members to be one family to face the challenges.



IFMSA-IRAQ

International Federation of Medical Students' Associations-Iraq

https://cdn.fsbx.com/v/t59.2708-21/240671500_647243062904382_2563092937191455831_n.pdf/partnership.pdf?nc_cat=107&ccb=1-5&nc_sid=0cab14&nc_ohc=HfcEzgr3IQAX8HL3cz&nc_ht=cdn.fsbx.com&oh=f315c7de940fc244e212c213e0a4798e&oe=61753EAF&dl=1

<https://www.facebook.com/IFMSA.IQ/>

[https://instagram.com/ifmsa_iraq?utm_medium=copy link](https://instagram.com/ifmsa_iraq?utm_medium=copy_link)



Student organizations 5:

(Team S2) **Team Security 2** is a **University of Basrah students** volunteer team for helping empowering cyber security and enhancing awareness for the internet users. The Team S2 was established in 2019 by a group of students who want to change and put more efforts to protect people from hackers and teach them the advantages and disadvantages of using internet in very simple way.

https://t.me/iraq_a_s_d/13578

🌐 Join university of Basrah students' media channel through the telegram program:

https://t.me/iraq_a_s_d



Shanasheel Technical Team:

A group of creative young men and women from Basra Al-Fayhaa, the number of the team is 75 artists in various fields, painters, calligraphers, and handicraft owners, including 30 students from the University of Basra, the team was founded in 10/11/2018.



UNIVERSITY OF BASRAH SUSTAINABILITY REPORT



The team participated in many exhibitions and festivals, and also organized many exhi



<https://www.instagram.com/shanasheel.art/>



6. 5. Cultural activities related to sustainability

Cultural activity 1: University of Basrah organizing international exhibit entitled Corona is a pandemic and rise.

<http://bfac.uobasrah.edu.iq/news/876>





Cultural activity 2: Basra University revives (puppet theater) again after it was marginalized for years, the College of Fine Arts at the University of Basra, with exceptional and distinguished efforts, organized the first international electronic festival for puppet theater. The festival included 13 Arab and foreign artworks among the 25 works submitted for participation. The Iraqi theatrical event that attracted artists from 15 countries in the Arab world and beyond, such as Switzerland, Italy and Colombia.

<https://bfac.uobasrah.edu.iq/index.php/2016-06-29-21-44-43/9511-2020-06-01-11-19-01.html>

<https://mail.uobasrah.edu.iq/news/368>





Cultural activity 3: The 1st International Virtual Monodrama Theater Festival.



<https://mail.uobasrah.edu.iq/news/368>

Cultural activity 4: University of Basrah organizing the first virtual mobile cinema festival.



<https://mail.uobasrah.edu.iq/news/368>



Cultural activity 5: University of Basrah president inaugurate the Artistic Products Marketing Center. <https://bfac.uobasrah.edu.iq/index.php/2016-06-29-21-44-43/9504-v.html>





6. 6. University programs to deal with the Covid-19 epidemic

From the outset, University of Basrah has prepared to face the challenges of continuing education despite urban conditions and immediate treatments have been developed to pass the stage and continue education at the university.

First: Launch the educational platform (let's learn):

University of Basrah, in collaboration with the Media and Communications Authority, has launched a learning platform supporting the Avicenna center that maintains the privacy of teaching and student. Below are the features provided by the Avicenna center's Support Learning Platform:

Platform interface

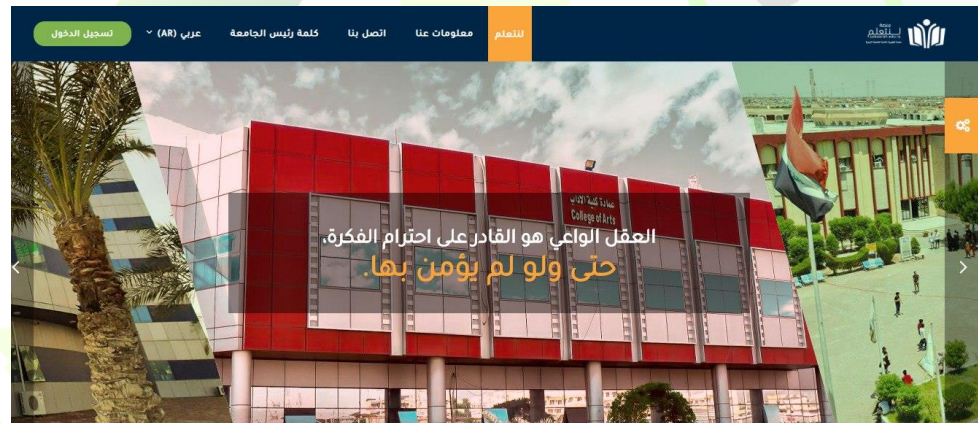

The Moodle platform provides an electronic learning management system (LMS).



UNIVERSITY OF BASRAH SUSTAINABILITY REPORT



Lectures are classified into a type-by-type learning platform to provide lcms and provide an electronic library linked to cloud storage in which lectures are stored by type.



The platform provides, linking with the application in smart devices and various operating systems to ensure easy access by the teaching and student.



The platform provides the Learning Event Management System (LMS), the image above showing the user's active chapters

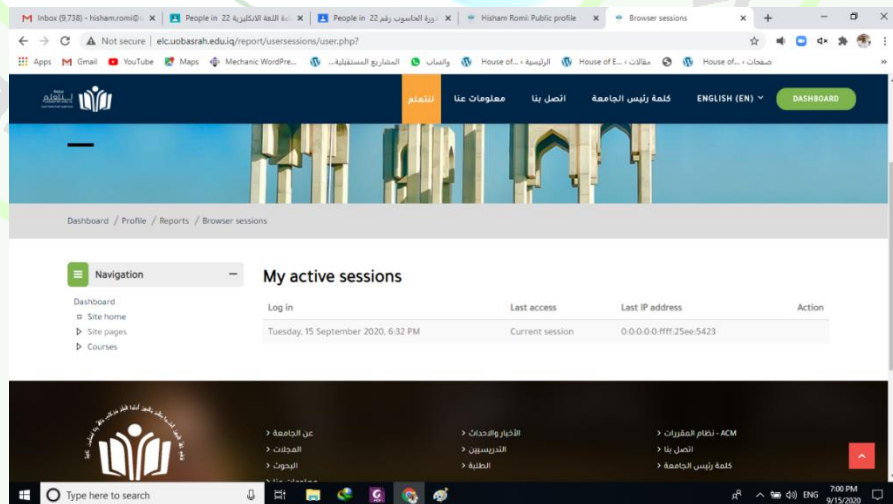

UNIVERSITY OF BASRAH SUSTAINABILITY REPORT



Events available for teaching to manage the virtual class, including meeting web to create a live lecture with students using the Big Blue Button BN program.

The platform contains a system for conducting electronic examinations and tests within its software design.

The platform (Moodle) is characterized by its programs are scalable and additions and the organization can develop services continuously, the image shows the addition of the possibility of meeting the Web using zoom program.

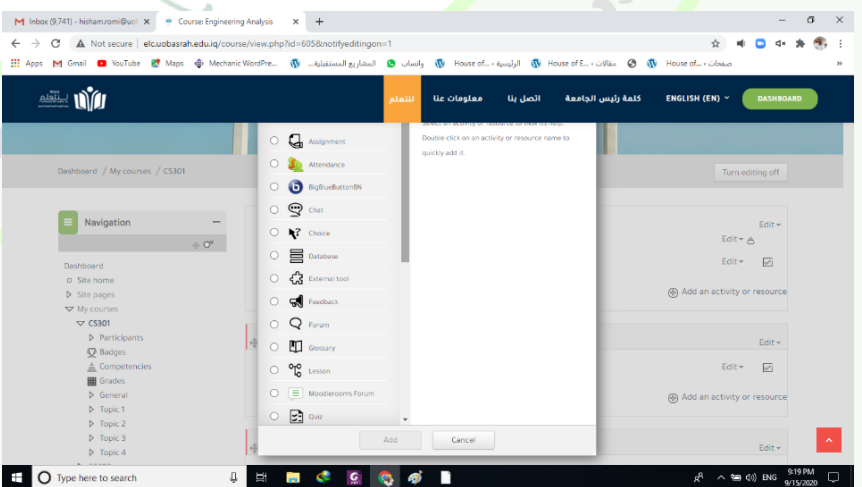
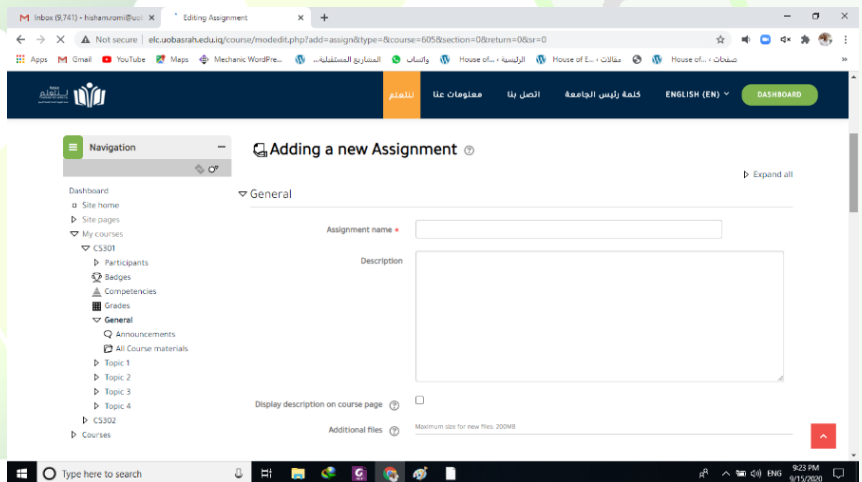
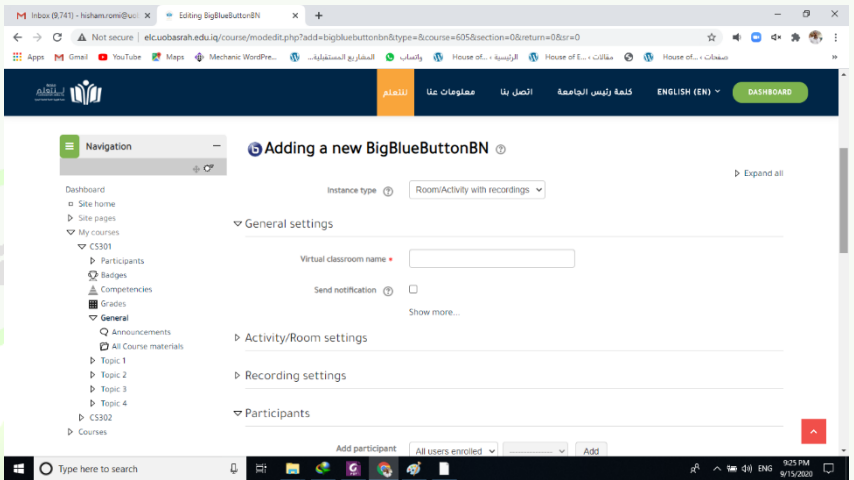



Second: Relaunching Radio Maddad:

The reopening of The Maddad Radio Channel in coordination with the Media and Communications Authority, which works on FM frequency at 90.90 frequency in Basra province to broadcast voice lectures to students in humanitarian lessons after maintenance and repairs.



<https://uobasrah.edu.iq/news/40>

Third: Launching A Lecture Campaign For Students Who Do Not Own Them:

University of Basrah adopted the proposal of the Ministry of Higher Education to deliver lectures to students in need in the first semester, where all departments and colleges of University of Basrah organized the lectures loaded at its Social Media, which opened two weeks after the start of the Corona pandemic and delivered to students in need everywhere.

Fourth: Launching Campaign To Help Students In Need:

University of Basrah has sent invitations to all institutions and charities in Basra province to help the students who are in need at the university, where many of these requests have been responded to and tablets (Tabs) and laptops have been provided to a group of students who in need, as well as to approach the Telecommunications Authority and Zain Iraq company for the purpose of providing free net support to students.

Fifth: Launch of the UOB SIS student information management platform at University of Basrah:

It is a platform for collecting, preserving, and managing student information from the moment he enters the university until he graduates and using programming



that can be applied to large numbers of students and the Internet with very simple specifications. The platform issues students' identities with a single barcode for each student to support the digital transformation to smart university, as well as the export of documents to graduates.

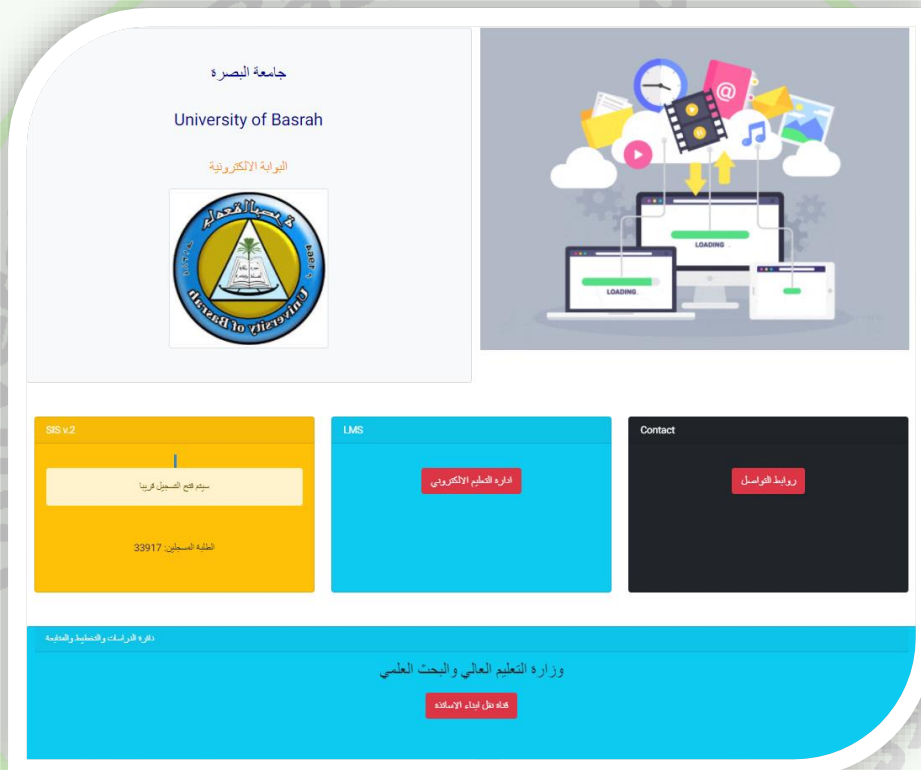

Above the entrance to the UOB SIS platform, where the first stage was completed by the platform, which is to enter the data of the first phase in the university to start the second phase by introducing all the students of the university, which number about 60 thousand students, and God bless.

<https://uobasrah.edu.iq/electronic>

<http://contact.uobasrah.edu.iq>



6th: UOB LMS learning Management Platform at University of Basrah:

University of Basrah uses the UOB LMS learning management platform at the link: <http://lms.uobasrah.edu.iq>

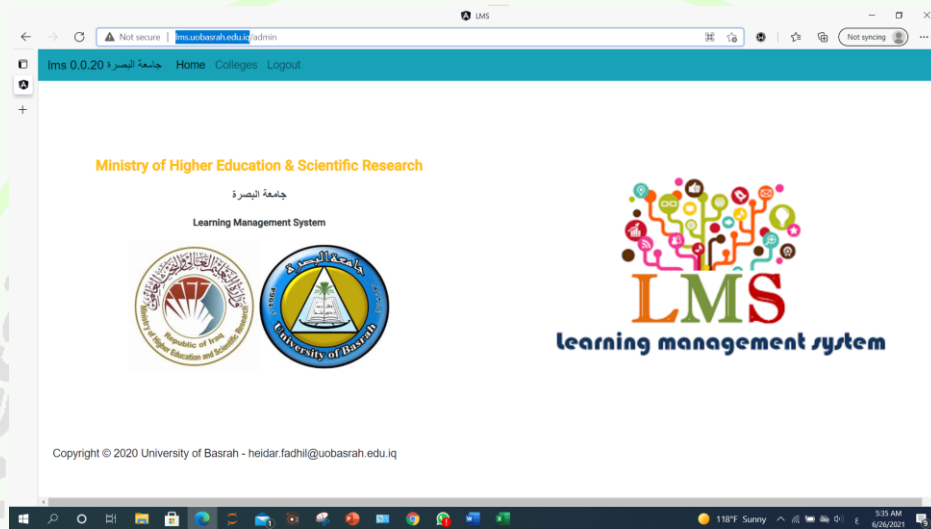

It is a platform for managing teaching schedules at University of Basrah using the latest methods and programming. This platform is characterized by a programmatic link with the UOB SIS platform to transmit information and ensure that students register the declared tables.

Seventh: UOB EXAM platform for managing exam classes at University of Basrah:

University of Basrah uses the UOB EXAM examination management platform at the link: <https://exam-ubafs.web.app>



University of Basrah programmers designed a digitally test management platform that is easy and fast to use because it is designed programmatically to be managed with very simple net packages. The platform issues all the necessary statistics during the performance of the exams to distinguish University of Basrah accurately and quickly complete the reports accompanying the exams.

8th: UOB MOOC Platform for Managing The Huge Open Educational Courses at University of Basrah:

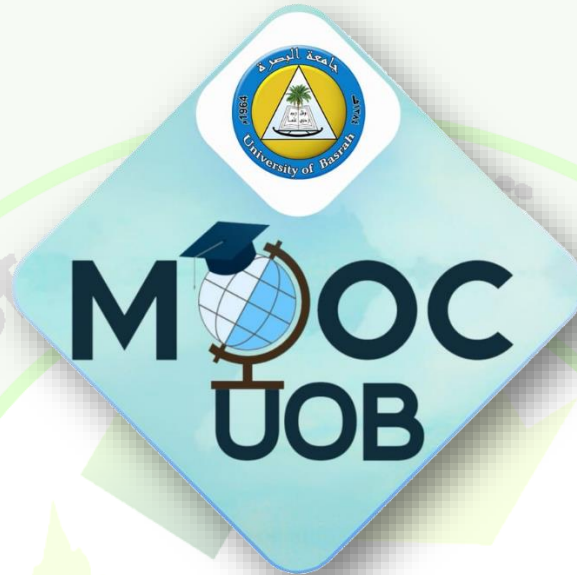

The Avicenna Center for E-Learning at University of Basrah has launched a website on large open-source courses offered free of charge via the Internet as this achievement comes as part of University of Basrah's efforts to achieve the standards of quality of e-learning for educational content, which stipulates that the foundation has a platform for large electronic educational courses and supports its use in regular education, academic training courses and life long learning. The large open-source courses aim to improve the level and efficiency of education by issuing virtual courses that promote lifelong learning for participants. Website link:

<https://mooc.avicenna.uobasrah.edu.iq>

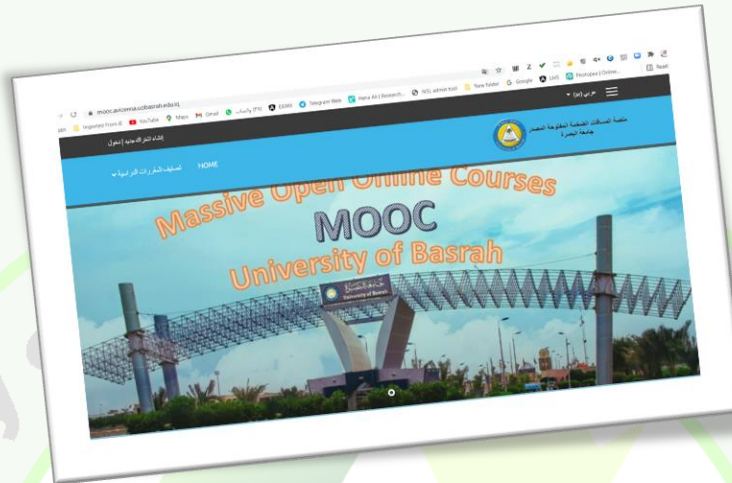

Ninth: UOB OER Open Educational Resources Platform at University of Basrah:



The Avicenna Center for E-Learning at University of Basrah has launched a website on open educational resources, which are provided free of charge online to achieve the quality standards of e-learning. Open educational resources aim to provide educational resources to participants for the purpose of utilizing them and using their content for the purpose of learning and self-wading. The site also includes easy access to educational training resources of all kinds.

<https://oer.avicenna.uobasrah.edu.iq>

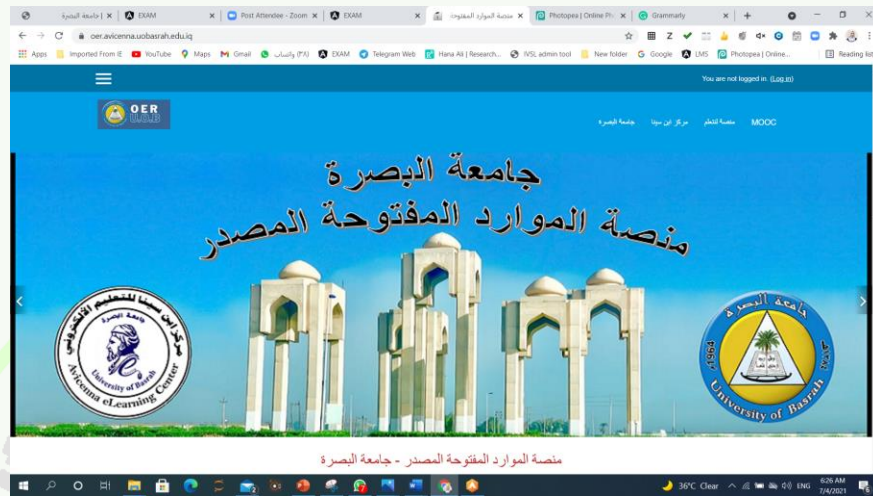

Tenth: University of Basrah program during exams:

Prior to the start of the final electronic examinations for the 2019/2020 academic year, the University has taken several measures to ensure the success of the examinations, including:

1. The formation of a central committee to follow up the electronic examinations for graduate students and the supplementary exam to the preliminary studies.
2. A university council held throughout the days of the examinations to stand up to the obstacles facing colleges and solve them as soon as they occur.
3. Held many meetings with various technicians and engineers specialized in the public and private sectors to benefit from their expertise in the field of information technology and Internet services.
4. Hold meetings with student representatives to reassure them and raise the barrier of fear of technical problems that students may face.
5. Follow-up the implementation of the recommendations and instructions of the Ministry of Higher Education and Scientific Research by teaching staff.



The beginning of the electronic examinations at University of Basrah was with postgraduate studies, where more than 800 students performed electronic examinations for both master's and doctoral studies. The committees follow up the electronic examinations, whether the Central Committee in the presidency of the university or the sub-committees formed in all colleges of the university follow up the final examinations in coordination with the ministerial committees to follow up the final examinations.



Part of his Excellency the Minister of Education and Scientific Research's visit to University of Basrah



UNIVERSITY OF BASRAH SUSTAINABILITY REPORT

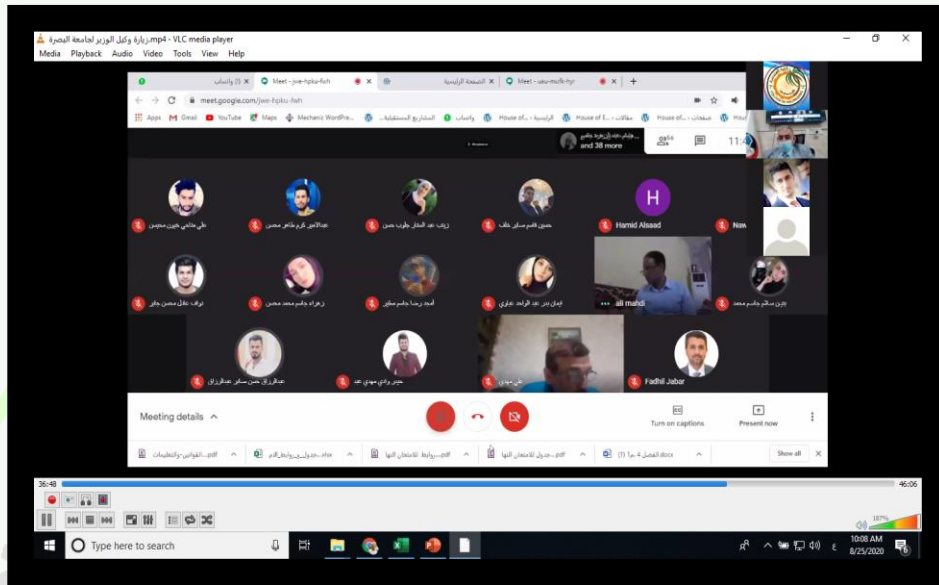

Part of the visit of The Deputy Minister for Scientific Research to one of the exam halls at University of Basrah

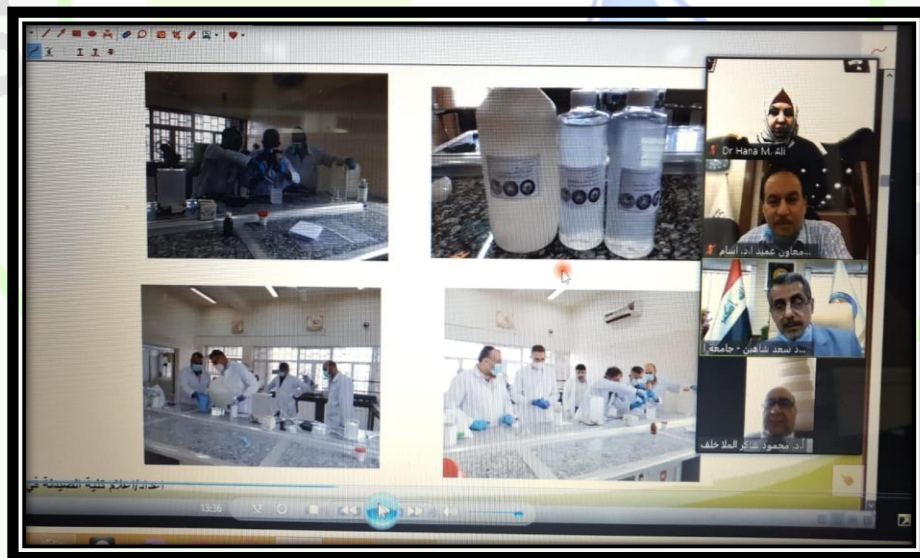

Part of the visit of Iraq's permanent representative to UNESCO to university of Basrah

UNIVERSITY OF BASRAH SUSTAINABILITY REPORT



Electronic examination follow-up room at University of Basrah

<https://youtu.be/hjYH-FMrscw>

https://youtu.be/vsgn_k4ZBxc

https://youtu.be/zXYj7RRJ_vs

<https://youtu.be/tsHp4TtuNvs>

<https://youtu.be/ZffSBVEXHsk>

<https://youtu.be/2eyPx9NHrgs>



Eleventh: Conferences held to evaluate the experience of e-learning at University of Basrah:

1. First Calendar Conference for Postgraduate Studies:

وزارة التعليم العالي والبحث العلمي
جامعة البصرة - كلية الدراسات العليا

برعاية السيد وزير التعليم العالي والبحث العلمي أ.د. نيل كاظم عبد الصاحب
وإشراف السيد رئيس جامعة البصرة أ.د. سعد شاهين حمادي

وخت شعار: دراسة وتقييم التجارب الجديدة خير وسيلة للوصول الى الرصانة العلمية المطلوبة

تقييم كلية الدراسات العليا في جامعة البصرة

المؤتمر التقويمي الاول للدراسات العليا

للمرسة وتقييم التعليم الالكتروني والامتحانات الالكترونية للعام الدراسي ٢٠١٩-٢٠٢٠ وذلك يوم الاحد المصادف
٢٠٢٠/٧/١٢ الساعة التاسعة صباحاً وعبر برنامج (Zoom)

Zoom Meeting ID: 885 4352 4549

اللجنة التحضيرية:

- ١- د. هشام لطيف سوادى- مدير مركز الحاسبية رئيساً
- ٢- ج.م. عمار عبد الجبار- كلية التربية قرنة - عضواً
- ٣- الاسمة نيا هاشم- كلية الدراسات العليا- عضواً

اللجنة العلمية:

- ١- د. سعد شاهين حمادي- رئيس الجامعة- رئيساً
- ٢- د. زكي عبدالله احمد- مساعد رئيس الجامعة للشؤون العلمية- عضواً
- ٣- د. محمد حمزة عباس- امين مجلس الجامعة- عضواً
- ٤- ج.م. جلال جبار حسن- كلية الدراسات العليا- عضواً
- ٥- ج.م. علاء سامي خلف- معاون العميد العلمي لكلية الدراسات العليا- عضواً
- ٦- د. ج.م. محمد عبدالرشاد- مدير مركز ابن سينا للتعليم الالكتروني- عضواً
- ٧- د. احمد صدام عبدالصاحب- معاون العميد العلمي لكلية الإدارة والاقتصاد- عضواً

محاور المؤتمر:

- ١- طبيعة الاسئلة المحددة وزيارياً ، سلبياتها واجابياتها.
- ٢- الخيارات والبدائل لاستمرارية الامتحانات الالكترونية دون معوقات تقنية.
- ٣- البدائل المقترحة لتوثيق اجابات الطلبة وتصحيح الفقرات الامتحانية.
- ٤- الوسائل المقترحة للحفاظ على رصانة التعليم والامتحانات الالكترونية والتجارب الدولية في الامتحانات الالكترونية وامكانية الاستفادة منها.
- ٥- امكانية الاستفادة من التجربة الحالية لتطوير اساليب وطرق التعليم الحديثة.
- ٦- تطوير مهارات الطلبة لاستعمال المنصات التعليمية الافتراضية والحاسوب.

للمشاركة في احد محاور المؤتمر يرجى ارسال ورقة العمل الى البريد الالكتروني التالي:
h.evaluation@uobasrah.edu.iq

اختر موعداً لاستقبال أوراق العمل هو يوم الخميس المصادف ٢٠٢٠-٧-٩

سوف تمنح شهادات مشاركة للمشاركين بأوراق العمل

<https://uobasrah.edu.iq/news/716>

<https://www.schoolandcollegelistsings.com/XX/Unknown/1531567390416958/%D9>

[%83%D9%84%D9%8A%D8%A9-](#)

[%D8%A7%D9%84%D9%87%D9%86%D8%AF%D8%B3%D8%A9---](#)

[%D8%AC%D8%A7%D9%85%D8%B9%D8%A9-](#)

[%D8%A7%D9%84%D8%A8%D8%B5%D8%B1%D8%A9](#)



2. The First Calendar Conference for E-Learning:

Ministry of Higher Education and Scientific Research has announced that it will adopt the integrated education system for the 2020/2021 academic year, which requires a management method that is totally different from the method used to complete the requirements of the 2019/2020 school year. Under the auspices of his Excellency the Minister of Higher Education and Scientific Research A. Dr. Nabil Kazem Abdul Sahib and under the supervision of Mr. President of University of Basrah Prof. D. Saad Shaheen Hammadi, University of Basrah held its first calendar conference for e-education under the theme "E-education between evaluation and evaluation, our way to vision for the future" from 27 to 29/9/2020, representing a proactive step to prepare and prepare for all colleges of University of Basrah early for integrated education.

اللجنة العلمية

١. أ.د. سعد شاهين حمادي (رئيساً)
٢. أ.د. محمد حمزة عباس (عضواً)
٣. أ.د. مازن هواز عبدالرضا (عضواً)
٤. أ.د. عبدالواحد زيارة اسكندر (عضواً)
٥. أ.د. ضياء فالح عبدالله (عضواً)
٦. أ.د. سلمي عبدالباقي محمود (عضواً)
٧. أ.د.م. جلال جبار حسن (عضواً)
٨. أ.د.م. رمزي سالم علي (عضواً)

اللجنة التحضيرية

١. أ.د. زكي عبدالله احمد (رئيساً)
٢. أ.د. هناء مرتضى علي (عضواً)
٣. أ.د. شكري شامك فالح (عضواً)
٤. أ.د.م. حيدر عبدالحسن عيود (عضواً)
٥. أ.د.م. فكيمة عبدالكريم قاسم (عضواً)
٦. أ.د. هشام لطيف سوادى (عضواً)
٧. أ.د.م. حيدر جاسم فاضل (عضواً)
٨. أ.د.م. حيدر توري حسن (عضواً)

اللجنة الاعلامية

١. أ.د.م. احمد فرج فليح (رئيساً)
٢. أ.د.م. رغد سهيل عبد الله (عضواً)
٣. أ.د. عبد الحكيم عزيز مجني (عضواً)

اللجنة الاستشارية

١. أ.د. غسان حميد عبدالمجيد الوكيل الفني
٢. أ.د. محمود شامك الملا خلف ممثل العراق في منظمة اليونسكو (عضواً)
٣. أ.د.م. عامر سليم الامير عضو اللجنة الوزارية للدعم الفني (عضواً)

وزارة التعليم العالي والبحث العلمي
جامعة البصرة

برعاية معالي وزير التعليم العالي والبحث العلمي
الأستاذ الدكتور
نبيل كاظم عبد الصاحب المحترم
و بإشراف السيد رئيس جامعة البصرة
الأستاذ الدكتور
سعد شاهين حمادي المحترم
وتحت شعار
التعليم الإلكتروني بين التقويم و
التقويم، طريقنا للرويا المستقبلية
تقيم جامعة البصرة:
**المؤتمر التقويمي الافتراضي
الأول للتعليم الإلكتروني**
موقع المؤتمر:
27-29/9/2020
العراق / محافظة البصرة



الهدف والرؤيا

اتخذت جامعة البصرة خطوات جادة للإرتقاء بمعايير جودة التعليم الإلكتروني خلال العام الدراسي ٢٠١٩ / ٢٠٢٠، مع تفشي الوباء والذي حاولنا بكل السبل نجاح تطبيقه. يهدف هذا المؤتمر، رسم معالم التعليم الإلكتروني في الجامعة خلال العام الدراسي ٢٠٢٠ / ٢٠٢١ ضمن معايير الجودة من خلال تقييم التطبيق السابق (الإيجابيات و السلبيات) لنؤسس بذرة تجعل التعليم الإلكتروني مكملاً للتعليم التقليدي وتضع الركائز المستقبلية للمضي قدماً لتطبيق التعليم المدمج بما يضمن خدمة المجتمع.

مواعد مهمة

□ يبدأ إستلام أوراق العمل :
8/9/2020

□ آخر موعد لإستلام أوراق العمل:
22/9/2020

محاور المؤتمر

- المحور الأول: تقييم تطبيق التعليم الإلكتروني للعام الدراسي ٢٠١٩ / ٢٠٢٠ ومعايير الجودة.
- المحور الثاني: تقويم تجربة التعليم الإلكتروني، رؤية مستقبلية للتعليم المدمج.
- المحور الثالث: الإفتتاح على المجتمع (بين الأرشاد و تفعيل دور الجامعات في خدمة المجتمع).

وزارة التعليم العالي والبحث العلمي
جامعة البصرة

يتم استلام أوراق العمل على البريد الإلكتروني:
elearning.conf@uobasrah.edu.iq

للاستفسار والمعلومات التواصل على رقم الهاتف:
+9647802410145

تنويه:

- يجب ان تكون أوراق العمل ضمن محاور المؤتمر لأن تقبل الأوراق عد ذلك.
- ان لا تتجاوز مدة العرض ١٥ دقيقة لكل ورقة عمل.
- ترسل شهادات مشاركة للسادة المشاركين عن طريق الإيميل.
- المنصة المستخدمة في المؤتمر هي منصة الزووم.

The first virtual calendar conference for e-learning at University of Basrah

<https://youtu.be/P-o4zWKXhCo>

<https://uobasrah.edu.iq/news/1201>

<https://youtu.be/Hmi3hzQbMRY>





UNIVERSITY OF BASRAH SUSTAINABILITY REPORT





6. 7. Sustainability community services project organized and/or involving students

No.	Sustainability community services	Link
	 <p data-bbox="712 789 1110 930">University of Basrah supplies a sterile gel to Al-Jul republic hospital</p>	<p data-bbox="1156 804 1424 924">https://pharmacy.uobasrah.edu.iq/arch-ive/9589</p>
2	 <p data-bbox="753 1142 1084 1436">University of Basrah / Faculty of Pharmacy launches medical consultation initiative through social media applications</p>	<p data-bbox="1156 1236 1424 1356">https://pharmacy.uobasrah.edu.iq/arch-ive/9586</p>
3	 <p data-bbox="802 1507 1120 1751">University of Basrah provides medical supplies to Basra General Hospital to prevent Corona virus</p>	<p data-bbox="1156 1583 1424 1661">https://uobasrah.edu.iq/news/39</p>



4



University of Basrah offers a quantity of liquid sterile to al-Republican Hospital

<https://pharmacy.uobasrah.edu.iq/archive/9593>

5



The Faculty of Pharmacy distributes sterilization materials to checkpoints and controls of our security forces

<https://uobasrah.edu.iq/news/47>

6



University of Basrah's Faculty of Pharmacy provides financial assistance to low-income people

<https://pharmacy.uobasrah.edu.iq/archive/9605>



7



Basra University launches compassion initiative in all university colleges

Medicine Week 1

<https://med.uobasrah.edu.iq/archive/9448>

Medicine Week 2

<https://uobasrah.edu.iq/news/56>

Medicine Week 3

<https://med.uobasrah.edu.iq/news/2557>

8



University of Basrah provides food aid to chaste families

<https://uobasrah.edu.iq/news/45>



<p>9</p>	<p>University of Basrah donates medical supplies to Basra Teaching Hospital.</p>	<p>https://uobasrah.edu.iq/news/42</p>
<p>10</p>	 <p>The Faculty of Veterinary Medicine at University of Basrah donated a number of medical devices and materials to Basra General Hospital for the purpose of filling the shortage of medical devices due to the Corona Virus.</p>	<p>https://ve.uobasrah.edu.iq/archive/925</p> <p>0</p>
<p>11</p>	 <p>University of Basrah establishes voluntary muzzle manufacturing workshop for free distribution</p>	<p>https://aec.uobasrah.edu.iq/archive/92</p> <p>55</p>



12



جامعة البصرة
 تطلق جامعة البصرة مبادرتها الإنسانية
 لتوفير مواد التعقيم والتطهير لمواجهة جائحة
فيروس كورونا
 بيجز بأسعار مدعومة للقطاعات الحكومية والأهلية
للطلب والاستفسار يرجى الاتصال على الرقم
 07737105741

University of Basrah launches humanitarian initiative to support government efforts and humanitarian organizations in the face of the pandemic

<https://uobasrah.edu.iq/news/720>

by providing sterilization, disinfection, disinfection and large production cards to meet the need at highly subsidized prices

13



University of Basrah delivers protective masks to Basra Health Department

<https://uobasrah.edu.iq/news/221>



14



The volunteer research team at University of Basrah provides 100 food baskets

to the chaste families in conjunction with the holy month of Ramadan

<https://pharmacy.uobasrah.edu.iq/archive/9633>

15



University of Basrah and pharmacists' union organize health initiative to provide sterile women with special needs

<https://uobasrah.edu.iq/news/435>

16



University of Basrah and pharmacists' union organize campaign to distribute steriles to institutions in Basra to reduce the spread of

CORONA virus

<https://pharmacy.uobasrah.edu.iq/news/253>



17

The crisis cell at University of Basrah produces a new batch of muzzles, where the crisis cell at the Faculty of Education for the Humanities sewed the muzzles and distributed them free of charge to our security forces

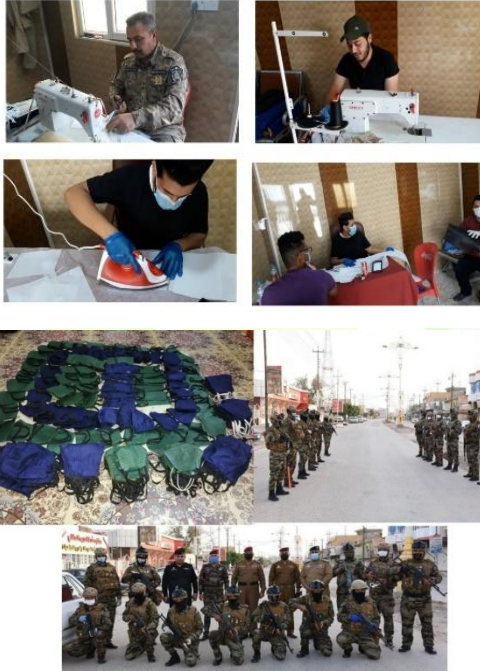

<https://uobasrah.edu.iq/news/302>

18



University of Basrah donates protective supplies to the central laboratory in the province

<https://uobasrah.edu.iq/news/305>



<p>19</p>		<p>University of Basrah distributes more than 220 food baskets to poor families in the province</p>	<p>https://uobasrah.edu.iq/news/347</p>
<p>20</p>		<p>On the generous initiative of the deans of the Faculties of Arts, Management and Economy, a large number of faculty members of the two colleges donated to the chaste families in Basra city..</p>	<p>https://uobasrah.edu.iq/news/353</p>
<p>21</p>		<p>University of Basrah launches campaign to encrypt the provinces and districts of the city</p>	<p>https://uobasrah.edu.iq/news/377</p>



University of Basrah visits home for the elderly to raise awareness of CORONAVIRUS

22



<https://uobasrah.edu.iq/news/221>

University of Basrah raises funds and buys oxygen

23



bottles for students of University of Basrah infected with Corona virus

<https://pharmacy.uobasrah.edu.iq/news/298>

24



Teachers and students of University of Basrah visit an orphanage

<https://www.uobasrah.edu.iq/index.php/2016-06-29-21-44-43/12822-2018-11-15-07-31-56.html>



25



University of Basrah organizes visit to orphanage and people with special needs

<https://aec.uobasrah.edu.iq/news/2443>

26



Mr. President of University of Basrah visits the State Bud Care House in Basra with The Dean of Zahra Medical College

<https://zahra.uobasrah.edu.iq/news/51>

22

27



Engineering college students organize a voluntary campaign entitled Engineering Our Home

<https://eng.uobasrah.edu.iq/archive/95>

51



The aim of the campaign is to repair the public property in the Faculty of Engineering and increase the elegance and beauty of the college, adding that



Under the Auspices of
The Prof. Dr. Saad Shaheen
President of Basrah University



***Under the slogan ***

((Let World Food Day be your day to share your personal initiatives to provide food for the poor))
The University of Basra invites you to present initiatives on this occasion in order to provide food for the poor .

Initiatives and aids are received at the colleges and centers sites starting from 3/10/2021 until 10/14/2021.
Food baskets will be distributed on October 16/10/ 2021



6.8. Number of sustainability-related startups :

Startup1:

Startup name: Viral Transport medium production for Covid-19 *

Startup area in UI Greenmetric questionnaire (SI, EC, WS, WR, TR, ED): Ensuring a healthy life and promoting well-being for all of all ages

URL: https://pharmacy.uobasrah.edu.iq/index.php/2017-12-30-11-29-21/9590-2020-03-24-07-13-40.html?fbclid=IwAR1vRj_2YvjD91CHiEosoExz2gKOTNS3-9rn91gs

Description: The University of Basrah / College of Pharmacy, Al-Zahra Medicine and Science managed to produce the first VTM a1 and VTM a2 medium as the first initiative in Iraq. The VTMs are produced in the laboratories of the College of Pharmacy in order to preserve and transfer the samples of the infected people. The product was manufactured with components and alternatives available at the University of Basrah. The medium is very important in detecting the disease, as some tests are incorrect due to the lack of this VTM because sometimes the virus degrades through poor preservation. Note that this material is scarce and not available in Iraq. Thus, A partnership was formed between the University of Basra and health departments in Iraq, according to which thousands of required VTM were provided to the Health Department in Basrah Province, and the product was distributed to most health departments in most Provinces of Iraq.

UNIVERSITY OF BASRAH SUSTAINABILITY REPORT



Iraq produces COVID-19 laboratory supplies to more rapidly test cases



First batch of locally produced VTM in Iraq to support national laboratories maintain COVID-19 testing. Photo: WHO/Iraq

Basra, Iraq, 5 April 2020 – In cooperation with the World Health Organization (WHO), the COVID-19 Crisis Cell of Basrah University in southern Iraq has successfully produced urgently needed laboratory supplies to speed up testing of suspected cases.

UNIVERSITY OF BASRAH SUSTAINABILITY REPORT



<https://uobasrah.edu.iq/news/38>

<https://uobasrah.edu.iq/news/44>

Al-Muthanna

<https://uobasrah.edu.iq/news/46>

Karbala

<https://pharmacy.uobasrah.edu.iq/archive/9602>

Dhi-Qar

<https://pharmacy.uobasrah.edu.iq/index.php/520-2012-12-24-18-47-45/9659-720-1440.html>

Al-Qadisiyah

<https://uobasrah.edu.iq/news/96>

Ministry of Health

<https://uobasrah.edu.iq/news/95>

Waste

<https://uobasrah.edu.iq/news/102>

Kirkuk and Nineveh

<https://uobasrah.edu.iq/news/121>

Wasit, Maysan and Muthanna

<https://uobasrah.edu.iq/news/182>

<https://www.facebook.com/watch/?v=209840590292636>



Startup2:

Startup name: Kit-Real-Time PCR

Startup area in UI Greenmetric questionnaire (SI, EC, WS, WR, TR, ED): ED

URL:

https://www.facebook.com/permalink.php?id=530079440514958&story_fbid=1418291891693704

Description: The cadres of the University of Basrah were able to manufacture a Kit-Real-Time PCR, which contains diagnostic materials for the Coronavirus that will help diagnose the virus in one step. It is also cheaper than imported kits and is fast in efficiency, which will reduce the burden on the Ministry of Health and contribute to confronting the epidemic with high efficiency. One of the specifications of the kit is that it is designed according to international standards and will be ready to work after being examined by the World Health Organization and the Ministry of Health for approval. The kit contains a set of materials for the examination of the coronavirus, where two genes specific to the coronavirus were used, one (E gene) and the second (Orfb1 gene), and these two genes were amplified by (Real-Time PCR). It will be an important, qualitative and national addition to confront the pandemic. After the examination procedures are completed, the partnership with the Ministry of Health will be activated for its distribution.

UNIVERSITY OF BASRAH SUSTAINABILITY REPORT



IQ (19)
جمهورية العراق
وزارة التخطيط
الجهز المركزي للتقييس والسيطرة النوعية

براءة اختراع (12)

(11) رقم البراءة: 6708
(21) رقم الطلب: 2020/160
(22) تاريخ تقديم الطلب: 2020/4/13
(51) التصنيف الدولي: C12Q1/70
(52) التصنيف العراقي: 6
(30) تاريخ طلب الأسبقية: - بلد الأسبقية: -
(45) تاريخ منح البراءة: 2021/7/11

(72) اسم المخترع وعنوانه:
1- بعد شامين جعفر
2- ابراهيم حسين جعفر عبد السادة / جامعة البصرة كلية طب الزهراء اربيل فرع الاحياء الجزيئية
3- مبرور شاكور جواد / الجامعة التقنية الجنوبية المعهد التقني البصرة القسم التمريض
4- مازن هادي عبد الرشيد / جامعة البصرة كلية طب الزهراء اربيل
5- بدرعبد الله عبد الوهاب لوليا / جامعة البصرة كلية الطب
6- بدرعبد الله هادي حسين / جامعة البصرة كلية الزراعة
7- ابراهيم حسن شري / جامعة البصرة كلية الزراعة
8- ابراهيم هادي جعفر عبد الله / جامعة البصرة كلية الزراعة
9- هادي عثمان عيسى فهد / جامعة البصرة كلية الزراعة
10- ابراهيم عارف عزيز حبيب / مدير مكتب منظمة الصحة العالمية في المنطقة الجنوبية في العراق
11- ابراهيم محمد حمزة عيسى / جامعة البصرة كلية الزراعة
12- اسم صياحيب البراءة: / السجلات اعلاه

(54) تسمية الاختراع:
نتاج عدة لجمع عينات السعال لفحص تواجد فيروس كورونا المستجد من المصابين.

منحت هذه البراءة استناداً لأحكام المادة (21) من قانون براءة الاختراع والنماذج الصناعية والمعلومات غير المفصح عنها والسجلات المتكاملة والأصناف النباتية رقم (65) لسنة 1970 المعدل وعلى مسؤولية المخترع.





<https://uobasrah.edu.iq/news/185>

Startup3:

Startup name: Production of Disinfectants and Sterilizers.

Startup area in UI Greenmetric questionnaire (SI, EC, WS, WR, TR, ED): WR

URL:

<https://www.facebook.com/%D9%85%D8%B1%D9%83%D8%B2-%D8%A8%D9%8A%D8%AA-%D8%A7%D9%84%D8%AE%D8%A8%D8%B1%D8%A9-%D9%84%D9%84%D8%AA%D8%B7%D9%88%D9%8A%D8%B1-%D9%88%D8%A7%D9%84%D8%A7%D8%A8%D8%AF%D8%A7%D8%B9-House-of-Experience-108693870873783>

Description: The University of Basrah /House of Expertise Produces Disinfection solutions for areas that witnessed a significant increase in the number of coronavirus infections in Basrah province. examination procedures are completed, the partnership with the Ministry of Health will be activated for its distribution.

Therefore, the Expert House Center for Development and Creativity agreed with governmental and humanitarian institutions to provide them with the specified quantities of Disinfection materials to start Disinfection operations, to confront the Coronavirus, and



to limit its spread. Furthermore, to cover the largest area for the distribution of the product, other production lines were opened in the College of Pharmacy, the College of Veterinary Medicine, and the College of Science, with the participation of students.

https://youtu.be/Xz_GA6t1oow

<https://almaalomah.me/2020/04/07/467232/>

<https://arabicradio.net/news/546>



UNIVERSITY OF BASRAH SUSTAINABILITY REPORT





Startup 4:

Startup name: Production of Respirators Devices

Startup area in UI Greenmetric questionnaire (SI, EC, WS, WR, TR, ED): ED

URL: <https://uobasrah.edu.iq/news/510>

Description:

Basrah province, like all other provinces of Iraq, faced fears regarding about its hospitals would not be able to receive the huge numbers of patients infected with the Coronavirus, especially with the closure of the borders of Iraq. The University of Basrah, with the capabilities of its cadres, took the initiative to manufacture respirators with international specifications and an oxygen dispensing device to provide an integrated solution to provide clean and saturated air for patients with the dreaded epidemic in record time.

Technical Specification	
Screen size	• 15 Inch Touch
Dimensions	• 60 x 60 x 160 cm
Weight	• 40 kg
Battery backup	• 9000 mAh @ 24V
Backup time	• 2 hours
Gas supply	• medical gas circuit system and/or oxygen
Alarm system	• Speakers
Network Connectivity	• Wired LAN and Wi-Fi 2.4GHz
Remote control	• Yes: smart phone or Windows/Linux machine
Maximum flow	• 120 L/min
Tidal volume	• Adult: 100 to 4000 mL • Pediatric: 20 to 350 mL
Maximum Inspiration Pressure	• 125 cmH2O
PEEP	• 0 to 90 cmH2O
Inspiration time	• 0.1 to 10 sec
Respiratory rate	• 1 to 100 b/min
Pressure Trig	• -0.5 to -20 cmH2O
Volume compensate	• 1 to 100 mL
Sigh Interval	• 1 to 60 min
Sigh Cycles	• 1 to 30
Pressure support	• 5 to 100 cmH2O
Ventilation modes	
V-A/C	• Volume Assist/Control
P-A/C	• Pressure Assist/Control
V-SIMV + PSV	• Volume-Synchronized Intermittent Mandatory Ventilation
P-SIMV + PSV	• Pressure-Synchronized Intermittent Mandatory Ventilation
PRVC	• Pressure Regulated Volume Control Ventilation
PRVC - SIMV	• Same As V-SIMV But Mandatory Ventilation Is PRVC Mode
PSV	• Pressure Support Ventilation Mode
CPAP	• Continuous Positive Airway Pressure





Startup 5:

Startup name: production of the protective mask for Covid-19

Startup area in UI Greenmetric questionnaire (SI, EC, WS, WR, TR, ED): Ensuring a healthy life and promoting well-being for all of all ages.

URL: <https://uobasrah.edu.iq/news/43>

Description: The House of Expertise at the University of Basrah was able to manufacture a transparent face shield to protect our heroes, the employees of the Ministry of Health, and the security forces in the first line of defense against the Corona Virus. This initiative came in cooperation with several institutions in Basrah Province, where a cooperative team included



members from University of Basrah, University of Basrah of Oil and Gas, Jadwal Al-Furat Company for the manufacture of plastic pipes, and the Iraqi Scientific Camp Group, was formed under the supervision and follow-up from the House of Expertise to design and produce a transparent protective mask which aimed at protecting workers in the front line of the defensive battle against coronavirus to reduce the chances of infection. within four days of continuous work, the team was able to design and produce the first batch of production, which was delivered to the Basrah Province Health Department after obtaining their approval on the product. several batches were also sent to another southern province in Iraq along with Basra Police Command and Traffic Police Directorate.



Startup 6:

Startup name: Virtual Summer Training for University of Basrah students.

Startup area in UI Greenmetric questionnaire (SI, EC, WS, WR, TR, ED): ED

URL: <https://uobasrah.edu.iq/news/1020>

Description: In cooperation with IREX and the Ministry of Higher Education and Scientific Research with the Rehabilitation and Employment Center at the University of Basrah, the university announced the launch of the summer training program for students exclusively and for all disciplines. The program includes a set of training workshops online via the Zoom platform, which aims to develop and refine students' skills (Professional Development) to qualify them for the labor market.

برنامج التدريب الصيفي الافتراضي 2020
طلبة جامعة البصرة

برنامج تدريبي متكامل يضم ورش تدريبية عديدة لتطوير المهارات القيادية والادارية والوظيفية لتأهيلهم الى سوق العمل بعد التخرج

التسجيل عبر الاستمارة

اون لاين عبر منصة الزووم

طلبة جامعة البصرة حصرا المرحلتين الثالثة والرابعة



Startup 7:

Startup name: Preparing and designing the electronic management program.

Startup area in UI Greenmetric questionnaire (SI, EC, WS, WR, TR, ED): Ensuring a healthy life and promoting well-being for all of all ages

URL: <http://www.uobasrah.edu.iq/news/250>

Description: The House of Expertise for Development and Creativity at the University of Basra launched an electronic platform to follow up on home quarantine for the infected people. The platform was launched in cooperation with the Basrah Health Department to monitor the infected people while they were at their houses, which has provided a direct communication between the doctors in the Basra Health Department and the infected people who were able to request help and received continuous inquiries about their health conditions. In addition, this platform enabled the patient to follow the countdown to the days of isolation and determine the time at which they were fully recovering.

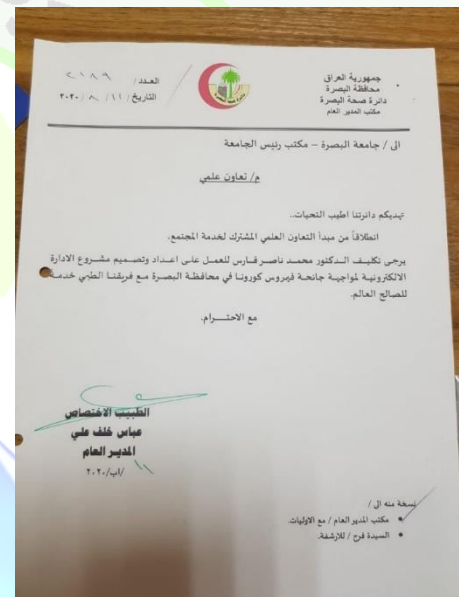



<https://www.almirbad.com/detail/57022>

Startup 8:

Startup name: Manufacture of a Disinfection system for ambulances

Startup area in UI Greenmetric questionnaire (SI, EC, WS, WR, TR, ED): EC

URL: <http://www.uobasrah.edu.iq/news/250>

Description: The House of Expertise Center for Development and Creativity at the University of Basra was able to manufacture and operate a system for Disinfect ambulances in cooperation with Al-Raedi Engineering Company. Those systems were developed to combat the Coronavirus pandemic. The system works on fogging ambulances in five minutes while the traditional methods were ranged from one to two hours.





Startup 9:

Startup name: Production of Disinfection Entrances

Startup area in UI Greenmetric questionnaire (SI, EC, WS, WR, TR, ED):EC

URL: <http://www.uobasrah.edu.iq/news/250>

Description: The House of Expertise at the University of Basra was able to manufacture Disinfection Entrance Devices For our educational institutions against Corona Virus. Those entrances were offered to several departments in Basrah province.





Startup 10:

Startup name: Production of The Respirator Mask

Startup area in UI Greenmetric questionnaire (SI, EC, WS, WR, TR, ED): Ensuring a healthy life and promoting well-being for all of all ages

URL: <https://uobasrah.edu.iq/news/807>

Description:

The College of Engineering at the University of Basrah, in cooperation with a research team from the British University of Leeds and an Iraqi medical team, was able to manufacture a respirator mask with

UBVM100 is oxygen driven assembly developed in university of Basrah. It consists of three main parts; Venturi with enrichment port, PEEP valve and one-way valve. The Venturi is provided by an additional oxygen port to enrich the oxygen. The air entrainment into the Venturi is controlled by the PEEP valve. The one-way valve serves as a safety valve to suck air when the delivery of the Venturi falls down.

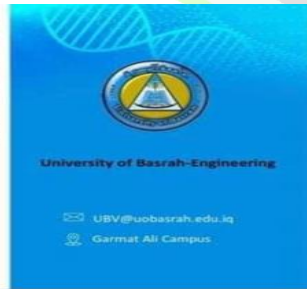

- UBVM100 has the main benefit of providing wide range of FIO₂ (21 to 100%) with
- UBVM100 have been attained after several experiments and calculations.
- All different parts of UBVM100 are manufactured in the University of Basrah, Engineering College.

O ₂ Flow A	O ₂ Flow B	FIO ₂ %	O ₂ Flow A+B	Air Flow	Total Flow	PEEP cm H ₂ O
5	0	22	5	1.3	6.3	10
10	0	47	10	20.5	30.5	10

high specifications, low cost, and high efficiency. The mask contains a set of specifications, including controlling the amount of flow L/min (the voltmeter - originally found in ordinary oxygen regulators), and in this model a double regulator (with two oxygen lines) is used to increase the control of high flow rates.

The air pressure in the respiratory tubes can also be controlled through the efficient design of a pressure control valve. This positive pressure is necessary for many cases, including those with coronavirus in the early and middle stages, and it has a role in opening the deflated alveoli.





Startup 11:

Startup name: Using blood plasma transfusion technology to heal patients infected with the Coronavirus.

Startup area in UI Greenmetric questionnaire (SI, EC, WS, WR, TR, ED): ED

URL: <https://uobasrah.edu.iq/news/807>

Description: The University of Basrah, in cooperation with the Basra Health Directorate, devised the process of extracting blood plasma for recovered patients that were infected with the Coronavirus. In this project, the plasma of those recovering from coronavirus was transferred to severe cases, hence their condition improved.





Startup 12:

Startup name: Preparing and designing the predictive program for the water reality in Basra province.

Startup area in UI Greenmetric questionnaire (SI, EC, WS, WR, TR, ED): WR

URL: <https://en.sustainability.uobasrah.edu.iq/news/10354>

Description:

Basrah province faces a problem with the scarcity of water access due to the policies of neighboring countries, which has made it a real need to find ways for having more knowledge about the water paths in Basrah. Therefore, cooperation was carried out between the University of Basrah and the local government in the province to design a program using the data available to predict the water situations of the province to overcome the problems that Basrah province has been experiencing for many years.



Startup 13:

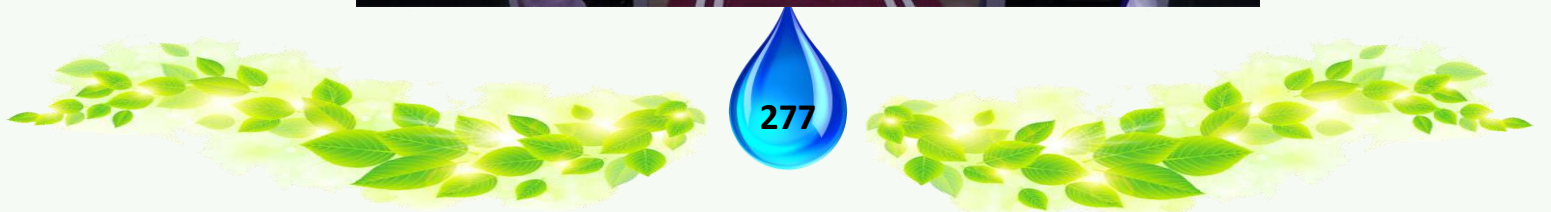



Startup name: Preparation and design of the central database of water status in Basrah province.

Startup area in UI Greenmetric questionnaire (SI, EC, WS, WR, TR, ED): WR

URL: <https://msc.uobasrah.edu.iq/index.php/2016-06-29-21-44-43/9653-2020-10-12-16-23-07.html>

Description: Water security is one of the main requirements for food security as it directly affects the nature and quantity of agricultural production as well as its impact on Agricultural plans development used for the economic development of our country as a whole. The issue of water security in Basrah can be considered in three dimensions, the first is related to global climate change and the second is domestic due to poor planning and management of water resources and the third is a regional dimension because water sources are outside Iraqi borders. Together, the University of Basrah had to provide scientific and technical consultations to be placed in the hands of decision-makers in the local and central government which has been done by forming a scientific team tasked with preparing a database to address the water status in the face of sudden population growth and changing lifestyles that led to significant challenges contributed to the increased demand for water.

<https://www.uobasrah.edu.iq/news/481>

Startup 14:

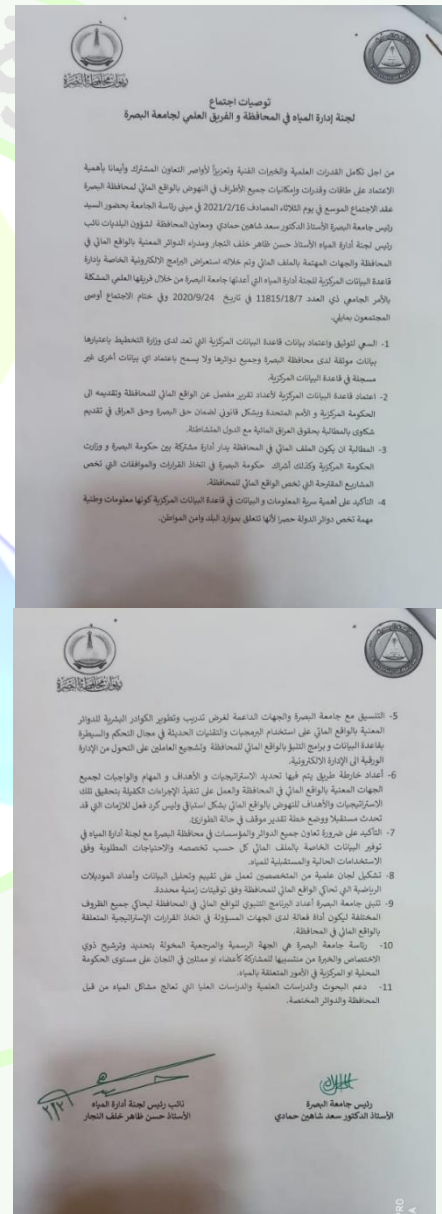



Startup name: Agriculture Support Partnerships

Startup area in UI Greenmetric questionnaire (SI, EC, WS, WR, TR, ED): EC

URL:

<https://msc.uobasrah.edu.iq/index.php/2016-06-29-21-44-43/9653-2020-10-12-16-23-07.html>

Description: One of the most important programs of the University of Basrah in preserving the climate and natural resources in the province of Basrah is to devote all the potential and energy to forming partnerships to serve this goal and focus on supporting agriculture. Thus, the University of Basrah cooperated with the Dutch government / the Dutch organization for internationalization Education Nuffic which is an independent non-profit organization based in The Hague, Netherlands, which is active in promoting capacity building in developing countries. This project started in 2019 under the title "Effective Water Management in Iraq through the Transition to Climate-Smart Agriculture: Capacity Building and Knowledge Development" where the project was built to support sustainable development in Basrah province through the university of Basrah. We hope that after the completion of the project, it would extend to other provinces in Iraq. We think that the use of smart agriculture and reclaimed lands will contribute to changing the climate in the governorate.

nuffic



Ministry of Foreign Affairs of the Netherlands



**IHE
DELFT**



building trust



Startup 15:

Startup name: COVID-19 Medical Swab Production Partnerships

Startup area in UI Greenmetric questionnaire (SI, EC, WS, WR, TR, ED): EC

URL: <https://uobasrah.edu.iq/news/144>

Description: The crisis cell of COVID-19 at the University of Basrah conducted a startup with Jadawel Alforat Company and the Industrial Coordination Chamber in Basrah Province for producing a kit for COVID-19 medical swabs as part of supporting the scientific team of the University of Basrah which were developing the viral transport media for COVID-19 at that time.





Startup 16:

Startup name: Establishment of a specialized university hospital

Startup area in UI Greenmetric questionnaire (SI, EC, WS, WR, TR, ED): SI

URL: <https://en.sustainability.uobasrah.edu.iq/sustainability-related-startups>

Description: The College of Engineering signed a contract to construct a specialized hospital for the University of Basrah to be one of the largest hospitals in the Basrah province that will relieve pressure on the other hospitals in the province. The achievement rate of the building works is 50% at this moment.



UNIVERSITY OF BASRAH SUSTAINABILITY REPORT

